Title	<i>Engineering Prototype Report (EP13) 43 W / 57 W pk, 5 Output TOPSwitch[®]-GX (TOP246Y) Power Supply</i>
Specification	185 - 265 V _{AC} input, 3.3 V / 3 A, 5 V / 3.2 A, 12 V / 0.6 A (1.8 A pk), 18 V / 0.5 A, 30 V / 0.03 A output. (Details for 115 V _{AC} conversion included)
Target Applications	Set top box with internal hard drive, or other multiple output applications
Author	Power Integrations Applications Department
Document Number	EPR-000013
Date	08-May-2001
Revision	1.0

Features

- Compact Design (6.875" L X 2.56" W X 1.56" H)
- 43 W steady state output power at 50 °C ambient, free convection
- High efficiency (75% minimum at 180 V_{AC} input, maximum continuous load)
- Low no-load power consumption (< 0.7 W @ 180 V_{AC}, < 0.8 W @ 265 V_{AC})
- Multiple section transformer for low cost automated production
- Excellent output voltage tracking and cross regulation
- Primary soft-start minimizes component stress during start-up
- Low conducted EMI due to frequency jittering: meets CISPR22B/EN55022B
- Line overvoltage shutdown provides extended line surge protection
- Hysteretic thermal shutdown allows automatic supply recovery after fault removal
- Low component count with single sided printed circuit board
- Surge immunity up to 4 kV (surge or 100 kHz ring wave)

Table Of Contents

1	Introduction	4
2	Power Supply Specification	5
3	Schematic	6
4	Circuit Description	7
5	PCB Layout	10
6	Bill Of Materials	11
7	Transformer Specification	13
	7.1 Electrical Specifications	13
	7.2 Materials	13
	7.3 Winding Instructions	14
	7.4 Transformer Sources	14
8	Transformer Spreadsheets	15
	8.1 230 V _{AC} , 60 W Peak Load	15
	8.2 230 V _{AC} , 45 W Steady State Load	18
9	Performance Data	21
	9.1 Efficiency	21
	9.2 No-load Input Power	21
	9.3 Regulation	22
	9.3.1 Maximum load all outputs	22
	9.3.2 Peak load all outputs	22
	9.3.3 3.3 V Min. load, 12 V peak, other outputs fully loaded	23
	9.3.4 12 V Min. load, other outputs at maximum load condition	23
	9.3.5 12 V Peak load, 30 V min. load, other outputs at max. load	24
	9.3.6 5 V and 3.3 V min load, all other outputs maximum	24
10	Thermal Performance	25
11	Waveforms	26
	11.1 Drain Voltage and Current, Normal Operation	26
	11.2 Output Voltage Start-up Profile	26
	11.3 Drain Voltage and Current Start-up Profile	27
	11.4 Load Transient Response (75% to 100% Load Step)	28
	11.5 Output Ripple Measurements	29
	11.5.1 Ripple Measurement Technique	29
	11.5.2 Measurement Results at 180 V _{AC}	30
	11.5.3 Measurement Results at 230 V _{AC}	31
12	Control Loop Measurements	32
	12.1 180 V _{AC} Maximum Load	32
	12.2 230 V _{AC} Maximum Load	33
	12.3 265 V _{AC} Maximum Load	34
13	Conducted EMI	35
14	AC Surge and 100 kHz Ring Wave Immunity	35
	14.1 Common Mode Surge, 1.2/50 μ sec	36
	14.2 Differential Mode Surge, 1.2/50 μ sec	36
	14.3 Common Mode, 100 kHz Ring Wave	37
	14.4 Differential Mode, 100 kHz Ring Wave	37



15	Appendix A – EP13, 115 V _{AC} Version	38
15.1	115 VAC Option Power Supply Specification.....	38
15.2	Schematic for EP13 115 V _{AC} -only Version.....	39
15.3	EP13 115 V _{AC} Version Circuit Description	40
15.4	EP13 115 V _{AC} Transformer Drawing.....	41
15.5	Electrical Specifications	41
15.6	Materials	42
15.7	Transformer Construction Diagram.....	42
15.8	Winding Instructions.....	43
15.8.1	Shield Foil Assembly	44
	Secondary Foil Assembly.....	44
15.8.3	Design Notes.....	44
15.9	EP13 115 V _{AC} Transformer Spreadsheets	45
15.9.1	115 V _{AC} , 60 W Peak Load	45
15.9.2	115 V _{AC} , 45 W Steady State Load.....	48
15.10	List of Included Parts for 230 VAC-115 VAC Conversion	51
15.11	EP13 230 VAC-115 VAC Conversion Instructions.....	51
15.11.1	Required Tools and Supplies.....	51
15.11.2	Conversion Instructions	51
16	Appendix B Miscellaneous Custom Parts	52
16.1	Secondary Heat Sink	52
17	Revision History	53



1 Introduction

This document is an engineering report describing a 230 V_{AC} input, 5-output flyback supply utilizing *TOPSwitch[®]-GX* (TOP246Y). The supply is rated for 43 W continuous output power, with 57 W of peak power capability for starting a disk drive. The design is optimized for high-end set-top box applications, but is easily adapted for other multiple output uses such as VCRs, DVD players, cable modems, and direct satellite receivers. The design kit includes a component kit and instructions for converting the supply to 115 V_{AC} input operation.

This document contains the power supply specification, schematic, and bill of materials, transformer documentation, printed circuit layout, and performance data.

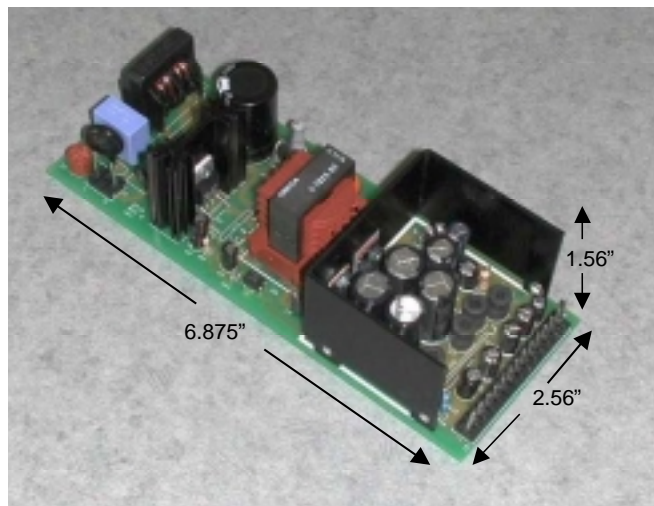

Figure 1 - EP13 Populated Circuit Board.



Figure 2 - EP13 230 VAC Input to 115 VAC Input Retrofit Kit.



2 Power Supply Specification

Description	Symbol	Min	Typ	Max	Units	Comment
Input						
Voltage	V_{IN}	180	230	265	V_{AC}	2 Wire – no P.E.
Frequency	f_{LINE}	47	50/60	64	Hz	
No-load Input Power (230 V_{AC})				0.75	W	
Output						
Output Voltage 1	V_{OUT1}	3.14	3.30	3.46	V	± 5% 20 MHz Bandwidth
Output Ripple Voltage 1	$V_{RIPPLE1}$			33	mV	
Output Current 1	I_{OUT1}	1.0	3.00	3.00	A	
Output Voltage 2	V_{OUT2}	4.75	5.00	5.25	V	±5% 20 MHz Bandwidth
Output Ripple Voltage 2	$V_{RIPPLE2}$			50	mV	
Output Current 2	I_{OUT2}	1.00	3.20	3.20	A	
Output Voltage 3	V_{OUT3}	11.16	12.0	12.84	V	±7% 20 MHz Bandwidth
Output Ripple Voltage 3	$V_{RIPPLE3}$			120	mV	
Output Current 3	I_{OUT3}	0.30	0.60	1.8*	A	
Output Voltage 4	V_{OUT4}	16.74	18.00	19.26	V	±7% 20 MHz Bandwidth
Output Ripple Voltage 4	$V_{RIPPLE4}$			180	mV	
Output Current 4	I_{OUT4}	0.5	-	0.5	A	
Output Voltage 5	V_{OUT5}	29.7	33	36.3	V	±10% 20 MHz Bandwidth
Output Ripple Voltage 5	$V_{RIPPLE5}$			200	mV	
Output Current 5	I_{OUT5}	0.01	-	0.03	A	
Total Output Power						
Continuous Output Power	P_{OUT}			43	W	
Peak Output Power	P_{OUT_PEAK}			57	W	
Efficiency	η	75			%	Measured at P_{OUT} (43 W), 25 °C
Environmental						
Conducted EMI						Meets CISPR22B / EN55022B Designed to meet IEC950, UL1950 Class II 1.2/50 μ s surge, IEC 1000-4-5, 12 Ω series impedance, differential and common mode
Safety						
Surge		4			kV	
Surge		4			kV	100 kHz ring wave, 500 A short circuit current, differential and common mode
Ambient Temperature	T_{AMB}	0		50	°C	Free convection, Sea level



3 Schematic

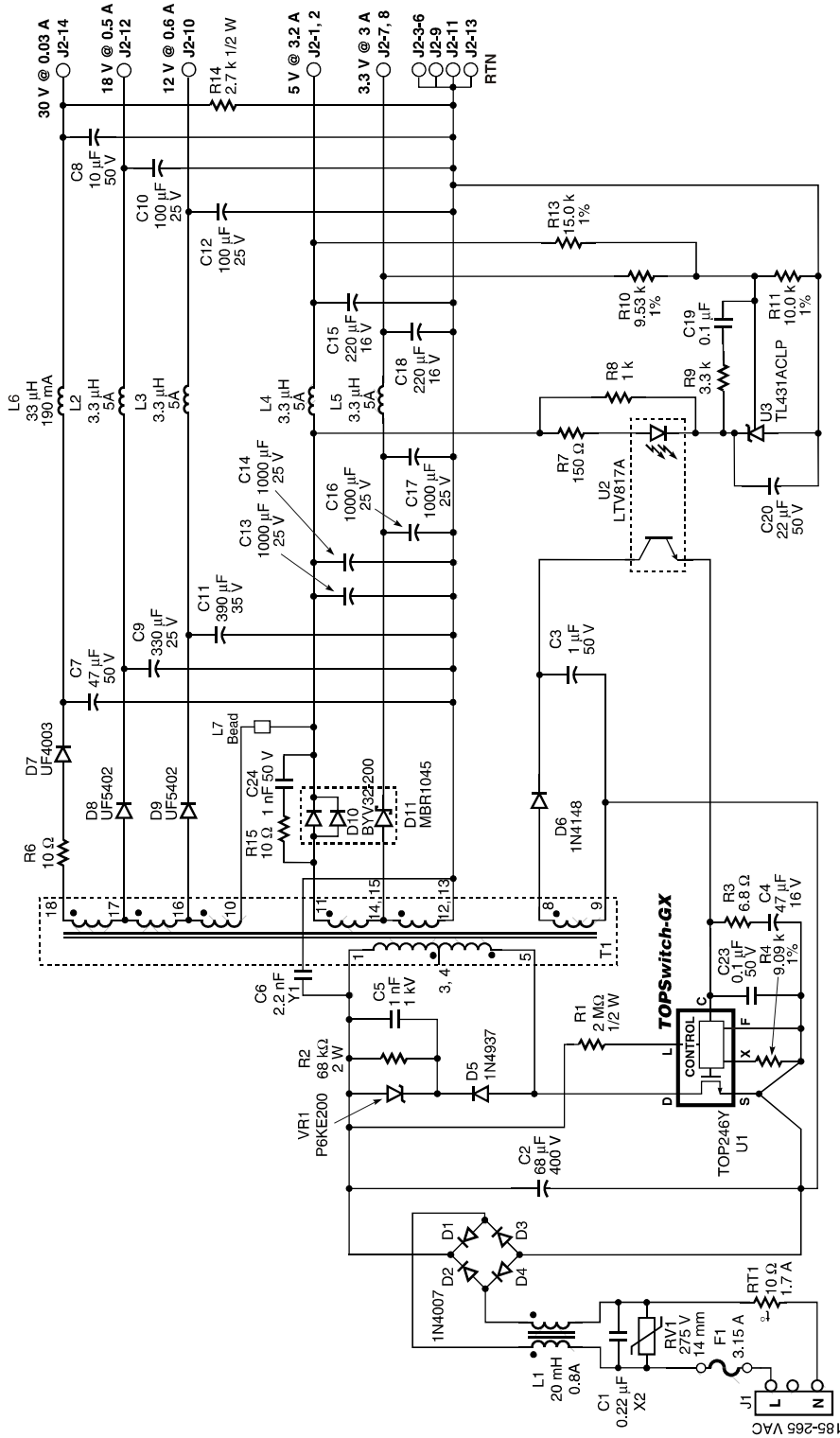

PI-2744-050101

Figure 3 - EP13 Schematic.

4 Circuit Description

The EP13 is a five-output flyback power supply using the TOP246Y integrated circuit. The circuit shown in Figure 3 provides 43 W continuous power, with peak capability of 57 W (thermally limited). Input voltage range is 180-265 V_{AC}.

AC input power is rectified and filtered by D1-4 and C2 to provide a high voltage DC bus, which is applied to the primary of transformer T1. The TOP246Y DRAIN pin drives the other side of the transformer primary. Components D5, VR1, R2 and C5 clamp the DRAIN voltage leakage inductance spike to below the 700 V maximum rating of the *TOPSwitch*.

The *TOPSwitch-GX* family provides several new features, as well as extended specifications. The EP13 power supply is designed to take advantage of several of these features.

Resistor R1 connected to the LINE SENSE pin (L) of *TOPSwitch-GX* U1 is used to implement the built-in line voltage feed forward and overvoltage protection features. The line feed forward feature modulates the control circuit of the *TOPSwitch-GX* with the AC line frequency ripple component of the input DC, reducing the line frequency ripple at the output of the supply. This simplifies the design of the power supply control loop by reducing the amount of control loop gain required at the line ripple frequency in order to meet output ripple specifications.

The overvoltage feature shuts down the power supply if the rectified DC bus voltage exceeds approximately 450 V, set by the value of R1. The supply resumes operation when the bus voltage falls again below the overvoltage threshold value. This feature allows the supply to withstand severe line transients or extended surge conditions without damage. This is an attractive feature for products designed for markets with poor power quality.

Resistor R4 connects to the EXTERNAL CURRENT LIMIT pin (X) of U1 and is used to externally program the device current limit to just above the peak primary current of the supply at maximum peak load, minimum line voltage. This allows the transformer to be better optimized for the chosen operating conditions, while at the same time avoiding transformer core saturation during start-up or overload conditions.

Transformer optimization choices can include using a smaller core (less expensive transformer), fewer primary turns (less leakage inductance), or higher primary inductance (more continuous operation, less *TOPSwitch* dissipation).

The EP13 transformer design does not take full advantage of the flexibility offered by the *TOPSwitch-GX* due to secondary volts per turn required to minimize voltage error between 3.3 V and 5 V outputs. The secondary turns were deliberately chosen to optimize output voltage centering with the fewest possible number of turns. The reflected



voltage at the primary was fixed at 100 V to optimize output cross regulation, thus fixing the number of primary turns. A design with fewer output voltages can take better advantage of the design flexibility offered by the *TOPSwitch-GX* family.

D6 and C3 provide a DC voltage of approximately 12 V to power the TOP246Y. A relatively large value of C3 (1 μ F) is used to provide bias voltage ride-through during severe output load transients.

Capacitor C4 filters the internal bias supply of the *TOPSwitch-GX*, providing the necessary peak currents to drive the gate of its internal high-voltage MOSFET. Capacitor C4 also determines the *TOPSwitch-GX* auto-restart frequency, and along with resistor R3, helps to compensate the power supply control loop.

Transformer T1 utilizes a nine section slotted bobbin designed for an automated production environment. Primary and secondary windings are applied in alternate bobbin slots using ordinary magnet wire. The slots provide the necessary safety isolation and creepage distance between the primary and secondary windings without the need for additional insulation of any kind. The large number of winding slots provides sufficient interleaving of primary and secondary windings to reduce the leakage inductance to a tolerable value, while the open construction of the transformer reduces winding temperature rise, allowing use of relatively fine wire, further facilitating automatic winding.

Diodes D7, 8, 9, 10 and 11, along with capacitors C7, 9, 11, 13, 14, 16 and 17 are used to rectify and filter the five output secondary windings of T1.

Two techniques are used to properly center the output voltages of the supply and to improve cross regulation between outputs. An ultrafast rectifier is used for D10 (5 V output rectifier) instead of a Schottky rectifier. The extra voltage drop of the ultrafast rectifier centers the 5 V output at precisely 5 V. Also, the 12 V, 18 V and 30 V secondary windings are stacked on the cathode side of the 5 V output rectifier (DC stacking) rather than the anode side (AC stacking). This means that the current for these outputs passes through the 5 V output rectifier (D10) as well as their respective output rectifiers (D7, 8, and 9). This increases the dissipation in D10, but has two beneficial effects. First, the extra voltage drop imposed by D10 precisely centers the 12 V output. Also, since the current for the 12 V, 18 V and 30 V outputs passes through D10 and its connecting printed circuit traces, variations in the current from these outputs will modulate the voltage drop across D10 to a certain extent. This change is passed on to the 5 V output, causing the output control loop to change the duty cycle to compensate. This indirect feedback improves the cross regulation of these outputs.

Inductors L2, 3, 4, 5 and 6 are used along with capacitors C8, 10, 12, 15 and 18 to provide high frequency filtering for the five outputs of the supply. These filters greatly reduce the switching frequency ripple and high frequency spike noise at the outputs of the supply.



A voltage divider consisting of resistors R10, 11 and 13 monitors the voltage on the 5 V and 3.3 V outputs. The resistor values are weighted so that the voltage feedback loop is controlled mostly by the 5 V output, with some contribution from the 3.3 V output. Sharing the voltage regulation control between the two outputs in this manner improves the cross regulation for the 3.3 V output at the expense of a slight change in the regulation of the 5 V output.

The voltage from R10, 11 and 13 is applied to the reference pin of shunt regulator U3. These resistor values and the reference voltage of U3 are used to set the output voltages of the supply. Resistor R7 is used to set the overall gain of the supply control loop, while R8 provides bias current for U3. R9 and C19 provide frequency compensation for U3 to help stabilize the power supply control loop. Capacitor C20 is used to provide open loop feedback through optocoupler U2 during start-up, which in conjunction with the built-in soft start-up feature of *TOPSwitch-GX*, completely controls the start-up drain current profile, preventing transformer saturation and output overshoot.

Optocoupler U2 applies the feedback signal from U3 to the CONTROL pin of U1.

Resistor R15 and capacitor C24 form a snubber across D10 that reduces the reverse recovery transient from this diode, improving EMI performance. Inductor L7 is a ferrite bead placed in series with the 12 V, 18 V and 30 V output windings of T1. This bead acts as a small saturable reactor to improve the centering and cross regulation of these outputs. R6 provides a small amount of pre-filtering for the 30 V output, and is used to help prevent peak charging of this output due to leakage spikes.

C1, L1 and C6 provide common-mode and differential mode EMI filtering for the power supply. Fuse F1 protects against gross circuit faults. Varistor RV1 is used to clamp differential mode line transients. Thermistor RT1 reduces the initial current surge when AC power is first applied to the circuit.



5 PCB Layout

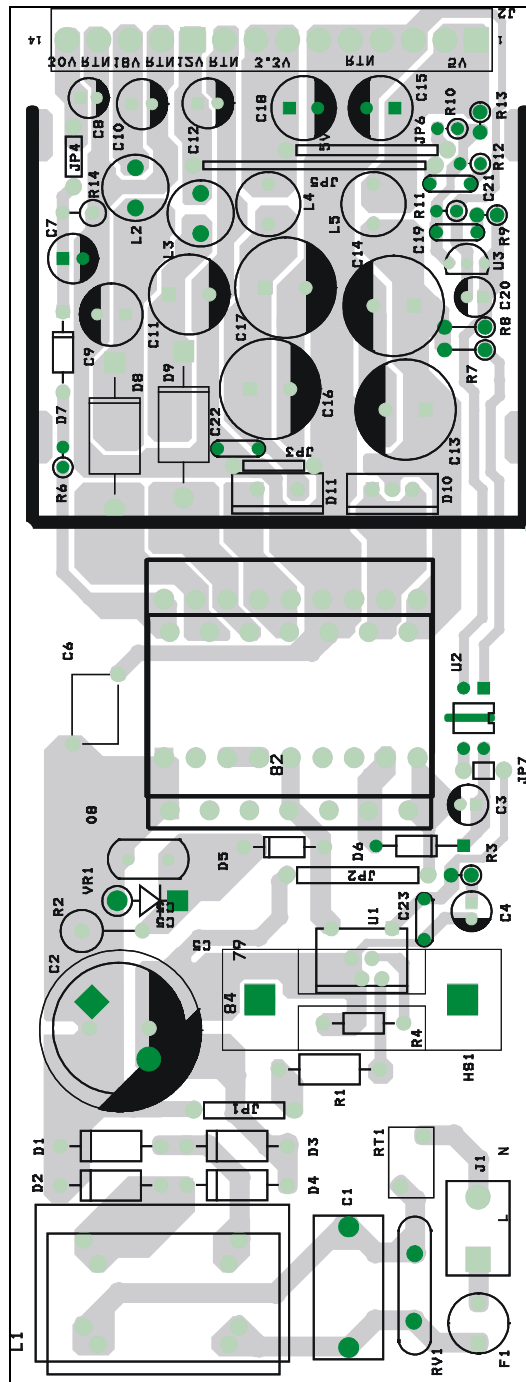

Figure 4 - EP13 Printed Circuit Layout. (Approximately 1:1 Scale)



6 Bill Of Materials

EP13 Set Top Supply, 230 VAC Slot Wound XFMR 1/25/01 Bill Of Materials

Item	Qty	Reference	Description	P/N	Manufacturer
1	1	C1	0.22 μ F 250 V, X2	306 20224	Philips
2	1	C2	68 μ F, 400 V	ECO-S2GP680AA	Panasonic
3	1	C3	1 μ F, 50 V NHG	ECA-1HHG010	Panasonic
4	1	C4	47 μ F 16 V NHG	ECA-1CHG470	Panasonic
5	1	C5	1 nF, 1 kV	ECK-D3A102KBN	Panasonic
6	1	C6	2.2 μ F, Y1	440LD22	Cera-Mite
7	1	C7	47 μ F, 50 V NHG	ECA-1HHGG470	Panasonic
8	1	C8	10 μ F, 50 V NHG	ECA-1HHG100	Panasonic
9	1	C9	330 μ F, 25 V HFQ	ECA-1EFQ331	Panasonic
10	2	C10, 12	100 μ F, 25 V NHG	ECA-1EHG101	Panasonic
11	1	C11	390 μ F, 35 V HFQ	ECA-1VFQ391	Panasonic
12	4	C13, 14,16,17	1000 μ F, 25 V HFQ	ECA-1EFQ102	Panasonic
13	2	C15, 18	220 μ F,16 V NHG	ECA-1CHG221	Panasonic
14	2	C19, 23	0.1 μ F, 50 V	K104M15Z5UF5TH5	Beyersschlag /Centralab
15	1	C20	22 μ F, 50 V NHG	ECA-1HHG220	Panasonic
16	1	C24	1 nF, 50 V	K102K15X7Rf5TL2	Beyersschlag /Centralab
17	4	D1-4	1 A, 1000 V	1N4007	
18	1	D5	1 A, 600 V, 200 nsec	1N4937	General Semiconductor
19	1	D6	Diode, 75 V	1N4148	
20	1	D7	1 A, 200 V, 50 nsec	UF4003	General Semiconductor
21	2	D8, 9	3 A, 200 V, 50 nsec	UF5402	General Semiconductor
22	1	D10	20 A, 200 V, 35 nsec	BYV32-200	Philips
23	1	D11	10 A, 45 V Schottky	MBR1045	General Semiconductor
24	1	F1	Fuse, 250 VAC 3.15 A	372-1315	Wickman
25	1	L1	20 mH, 0.8 A	ELF-18N008A	Panasonic
26	4	L2-5	3.3 μ H,	622-LY-3R3M	Toko
27	1	L6	33 μ H, 190 mA	78F330J	J.W. Miller
28	1	L7	Ferrite Bead	2643022401	Fair-Rite
29	1	R1	2 M, 1/2 W, 5%		
30	1	R2	68 k Ω , 2 W, 5% Metal Oxide		
31	1	R3	6.8 Ω , 1/4 W, 5%		
32	1	R4	9.09 k Ω , 1 %, RN55		
33	2	R6, 15	10 Ω , 1/4 W, 5%		
34	1	R7	150 Ω , 1/4 W, 5%		
35	1	R8	1 k Ω , 1/4 W, 5%		
36	1	R9	3.3 k Ω , 1/4 W, 5%		
37	1	R10	9.53 k Ω , 1%, RN55		
38	1	R11	10 k Ω , 1%, RN55		
39	1	R13	15 k Ω , 1%, RN55		
40	1	R14	2.7 k Ω , 1/2 W, 5%		



41	1	T1	XFMR, Custom Slotted Bobbin		Orega
42	1	U1	TOP246Y		Power Integrations
43	1	U2	Optocoupler, graded CTR	LTV817A	Liteon
44	1	U3	Shunt Regulator, 1%	TL431ACL	TI
45	1	RV1	Varistor, 275 VAC, 14 mm		
46	1	VR1	TVS, 200 V, 600 W	P6KE200	General Semiconductor
47	1	RT1	Thermistor, 10 ohm 1.7 A	KC012L	Keystone
48	1	J1	3 pin, 0.156 ctr*	26-60-2030	Molex
49	1	J2	14 pin, 0.156 ctr.	26-60-2140	Molex
50	1	HS1	Heat Sink, TO-220, 1.5" ht.	531102N02500	Aavid
51	1	HS2	Heat Sink		Custom



7 Transformer Specification

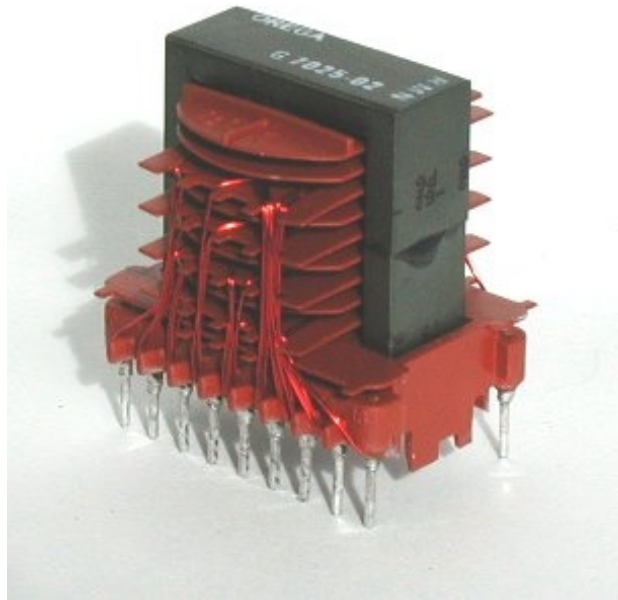

Figure 5 - EP13 Multiple Slot Transformer.

7.1 Electrical Specifications

Electrical Strength	1 minute, 60 Hz, from Pins 1-9 to Pins 10-18	3000 VAC
Primary Inductance	Pins 1-5 with Pins 3-4 shorted together, all other windings open, 130 kHz measurement frequency	487 μ H +/-10%
Resonant Frequency	Pins 1-5 with Pins 3-4 shorted together, all other windings open	2 MHz minimum
Primary Leakage Inductance	Pins 1-5 with Pins 3-4 shorted together, Pins 10-18 shorted together, 130 kHz measurement frequency	15 μ H maximum

7.2 Materials

Item	Description
[1]	Orega SMT18 Core/Bobbin Set, Gap core for A_L of 180 nH/T ²
[2]	Magnet Wire, Solderable Double Coated 0.25 mm/30 AWG
[3]	Epoxy Glue



7.3 Winding Instructions

Slot #	Start Pin	Turns	Wire size	Finish Pin
Slot 1 –	Start Pin 5	26t	0.25 mm	Finish Pin 3
Slot 2 –	Start Pin 11	1t	0.25 mm	Finish Pin 14
	Start Pin 14	2t	0.25 mm	Finish Pin 12
	Start Pin 16	4t	0.25 mm	Finish Pin 10
	Start Pin 17	3t	0.25 mm	Finish Pin 16
	Start Pin 18	6t	0.25 mm	Finish Pin 17
Slot 3 –	Start Pin 3	26t	0.25 mm	Finish Pin 1
	Start Pin 8	7t	0.25 mm	Finish Pin 9
Slot 4 –	Start Pin 11	1t	0.25 mm	Finish Pin 14
	Start Pin 14	2t	0.25 mm	Finish Pin 12
	Start Pin 14	2t	0.25 mm	Finish Pin 12
Slot 5 –	Start Pin 5	26t	0.25 mm	Finish Pin 4
Slot 6 –	Start Pin 11	1t	0.25mm	Finish Pin 15
	Start Pin 15	2t	0.25mm	Finish Pin 13
	Start Pin 15	2t	0.25 mm	Finish Pin 13
	Start Pin 16	4t	0.25 mm	Finish Pin 10
Slot 7 –	Start Pin 4	26t	0.25 mm	Finish Pin 1
Slot 8 –	Start Pin 11	1t	0.25 mm	Finish Pin 15
	Start Pin 15	2t	0.25 mm	Finish Pin 13
	Start Pin 16	4t	0.25 mm	Finish Pin 10
	Start Pin 17	3t	0.25 mm	Finish Pin 16
	Start Pin 18	6t	0.25 mm	Finish Pin 17
Slot 9 –	Start Pin 5	26t	0.25 mm	Finish Pin 4

7.4 Transformer Sources

For information on the vendors used to source the transformers used on this board, please visit the *Power Integrations'* Web site at the URL below and select "Engineering Prototype Boards"

<http://www.powerint.com/componentsuppliers.htm>



8 Transformer Spreadsheets

8.1 230 V_{AC}, 60 W Peak Load

ACDC_TOPGX_Rev1.1_040401 Copyright Power Integrations Inc. 2000	INPUT	INFO	OUTPUT	UNIT	TOP_GX_040401.xls: TOPSwitch-GX Continuous/Discontinuous Flyback Transformer Design Spreadsheet
ENTER APPLICATION VARIABLES					Customer
VACMIN	180			Volts	Minimum AC Input Voltage
VACMAX	265			Volts	Maximum AC Input Voltage
fL	50			Hertz	AC Mains Frequency
VO	3.3			Volts	Output Voltage
PO	60			Watts	Output Power
n	0.7				Efficiency Estimate
Z	0.5				Loss Allocation Factor
VB	12			Volts	Bias Voltage
tC	3			mSeconds	Bridge Rectifier Conduction Time Estimate
CIN	68			μFarads	Input Filter Capacitor
ENTER TOPSwitch-GX VARIABLES					
TOP-GX	TOP246			Universal	115 Doubled/230 V
Chosen Device		TOP246	Power Out	90 W	150 W
KI	0.8				External ILIMIT reduction factor (KI=1.0 for default ILIMIT, KI <1.0 for lower ILIMIT)
ILIMITMIN			1.944	Amps	Use 1% resistor in setting external ILIMIT
ILIMITMAX			2.376	Amps	Use 1% resistor in setting external ILIMIT
Frequency - (F)=130 kHz, (H)=65 kHz	f				Full (F) frequency option - 130 kHz
fS	130000		1.30E+05	Hertz	TOPSwitch-GX Switching Frequency: Choose between 130 kHz and 65 kHz
fSmin			1.24E+05	Hertz	TOPSwitch-GX Minimum Switching Frequency
fSmax			1.40E+05	Hertz	TOPSwitch-GX Maximum Switching Frequency
VOR	99			Volts	Reflected Output Voltage
VDS	10			Volts	TOPSwitch on-state Drain to Source Voltage
VD	0.5			Volts	Output Winding Diode Forward Voltage Drop
VDB	0.7			Volts	Bias Winding Diode Forward Voltage Drop
KP	0.60				Ripple to Peak Current Ratio (0.4 < KRP < 1.0 : 1.0 < KDP < 6.0)
ENTER TRANSFORMER CORE/CONSTRUCTION VARIABLES					
Core Type	EER28L				
Core		EER28L		P/N:	PC40EER28L-Z
Bobbin		EER28L_BOBBIN		P/N:	BEER-28L-1112CPH
AE			0.814	cm^2	Core Effective Cross Sectional Area
LE			7.55	cm	Core Effective Path Length
AL			2520	nH/T^2	Ungapped Core Effective Inductance
BW			21.8	mm	Bobbin Physical Winding Width
M	0			mm	Safety Margin Width (Half the Primary to Secondary Creepage Distance)
L	3.3				Number of Primary Layers
NS	2				Number of Secondary Turns



DC INPUT VOLTAGE PARAMETERS					
VMIN			217	Volts	Minimum DC Input Voltage
VMAX			375	Volts	Maximum DC Input Voltage
CURRENT WAVEFORM SHAPE PARAMETERS					
DMAX			0.32		Maximum Duty Cycle
IAVG			0.39	Amps	Average Primary Current
IP			1.74	Amps	Peak Primary Current
IR			1.05	Amps	Primary Ripple Current
IRMS			0.72	Amps	Primary RMS Current
TRANSFORMER PRIMARY DESIGN PARAMETERS					
LP			460	μHenries	Primary Inductance
NP			52		Primary Winding Number of Turns
NB			7		Bias Winding Number of Turns
ALG			169	nH/T^2	Gapped Core Effective Inductance
BM			1891	Gauss	Maximum Flux Density at PO, VMIN (BM<3000)
BP			2577	Gauss	Peak Flux Density (BP<4200)
BAC			567	Gauss	AC Flux Density for Core Loss Curves (0.5 X Peak to Peak)
ur			1860		Relative Permeability of Ungapped Core
LG			0.56	mm	Gap Length (Lg > 0.1 mm)
BWE			71.94	mm	Effective Bobbin Width
OD			1.38	mm	Maximum Primary Wire Diameter including insulation
INS			0.09	mm	Estimated Total Insulation Thickness (= 2 * film thickness)
DIA			1.29	mm	Bare conductor diameter
AWG			17	AWG	Primary Wire Gauge (Rounded to next smaller standard AWG value)
CM			2048	Cmils	Bare conductor effective area in circular mils
CMA		Warning	2864	Cmils/Amp	!!!!!!!!! DECREASE CMA> (decrease L (primary layers), increase NS, smaller Core)
TRANSFORMER SECONDARY DESIGN PARAMETERS (SINGLE OUTPUT / SINGLE OUTPUT EQUIVALENT)					
Lumped parameters					
ISP			45.43	Amps	Peak Secondary Current
ISRMS			26.95	Amps	Secondary RMS Current
IO			18.18	Amps	Power Supply Output Current
IRIPPLE			19.89	Amps	Output Capacitor RMS Ripple Current
CMS			5390	Cmils	Secondary Bare Conductor minimum circular mils
AWGS			12	AWG	Secondary Wire Gauge (Rounded up to next larger standard AWG value)
DIAS			2.05	mm	Secondary Minimum Bare Conductor Diameter
ODS			10.90	mm	Secondary Maximum Outside Diameter for Triple Insulated Wire
INSS			4.42	mm	Maximum Secondary Insulation Wall Thickness
VOLTAGE STRESS PARAMETERS					
VDRAIN			603	Volts	Maximum Drain Voltage Estimate (Includes Effect of Leakage Inductance)
PIVS			18	Volts	Output Rectifier Maximum Peak Inverse Voltage
PIVB			60	Volts	Bias Rectifier Maximum Peak Inverse Voltage



TRANSFORMER SECONDARY DESIGN PARAMETERS (MULTIPLE OUTPUTS)					
1st output					
VO1	5.0			Volts	Output Voltage
IO1	3.200			Amps	Output DC Current
PO1		16.00		Watts	Output Power
VD1	0.7			Volts	Output Diode Forward Voltage Drop
NS1		3.00			Output Winding Number of Turns
ISRMS1		4.743		Amps	Output Winding RMS Current
IRIPPLE1		3.50		Amps	Output Capacitor RMS Ripple Current
PIVS1		27		Volts	Output Rectifier Maximum Peak Inverse Voltage
CMS1		949		Cmils	Output Winding Bare Conductor minimum circular mils
AWGS1		20		AWG	Wire Gauge (Rounded up to next larger standard AWG value)
DIAS1		0.81		mm	Minimum Bare Conductor Diameter
ODS1		7.27		mm	Maximum Outside Diameter for Triple Insulated Wire
2nd output					
VO2	12.0			Volts	Output Voltage
IO2	0.600			Amps	Output DC Current
PO2		7.20		Watts	Output Power
VD2	1.4			Volts	Output Diode Forward Voltage Drop
NS2		7.05			Output Winding Number of Turns
ISRMS2		0.889		Amps	Output Winding RMS Current
IRIPPLE2		0.66		Amps	Output Capacitor RMS Ripple Current
PIVS2		63		Volts	Output Rectifier Maximum Peak Inverse Voltage
CMS2		178		Cmils	Output Winding Bare Conductor minimum circular mils
AWGS2		27		AWG	Wire Gauge (Rounded up to next larger standard AWG value)
DIAS2		0.36		mm	Minimum Bare Conductor Diameter
ODS2		3.09		mm	Maximum Outside Diameter for Triple Insulated Wire
3rd output					
VO3	18.0			Volts	Output Voltage
IO3	0.500			Amps	Output DC Current
PO3		9.00		Watts	Output Power
VD3	1.4			Volts	Output Diode Forward Voltage Drop
NS3		10.21			Output Winding Number of Turns
ISRMS3		0.741		Amps	Output Winding RMS Current
IRIPPLE3		0.55		Amps	Output Capacitor RMS Ripple Current
PIVS3		91		Volts	Output Rectifier Maximum Peak Inverse Voltage
CMS3		148		Cmils	Output Winding Bare Conductor minimum circular mils
AWGS3		28		AWG	Wire Gauge (Rounded up to next larger standard AWG value)
DIAS3		0.32		mm	Minimum Bare Conductor Diameter
ODS3		2.14		mm	Maximum Outside Diameter for Triple Insulated Wire



8.2 230 V_{AC} 45 W Steady State Load

ACDC_TOPGX_Rev1.1_040401 Copyright Power Integrations Inc. 2000	INPUT	INFO	OUTPUT	UNIT	TOP_GX_040401.xls: TOPSwitch-GX Continuous/Discontinuous Flyback Transformer Design Spreadsheet
ENTER APPLICATION VARIABLES					Customer
VACMIN	180			Volts	Minimum AC Input Voltage
VACMAX	265			Volts	Maximum AC Input Voltage
fL	50			Hertz	AC Mains Frequency
VO	3.3			Volts	Output Voltage
PO	45			Watts	Output Power
n	0.75				Efficiency Estimate
Z	0.5				Loss Allocation Factor
VB	12			Volts	Bias Voltage
tC	3			mSeconds	Bridge Rectifier Conduction Time Estimate
CIN	68			μFarads	Input Filter Capacitor
ENTER TOPSwitch-GX VARIABLES					
TOP-GX	TOP246			Universal	115 Doubled/230 V
Chosen Device		TOP246	Power Out	90 W	150 W
KI	0.8				External ILIMIT reduction factor (KI=1.0 for default ILIMIT, KI <1.0 for lower ILIMIT)
ILIMITMIN			1.944	Amps	Use 1% resistor in setting external ILIMIT
ILIMITMAX			2.376	Amps	Use 1% resistor in setting external ILIMIT
Frequency - (F)=130 kHz, (H)=65 kHz	f				Full (F) frequency option - 130 kHz
fS	130000		1.30E+05	Hertz	TOPSwitch-GX Switching Frequency: Choose between 130 kHz and 65 kHz
fSmin			1.24E+05	Hertz	TOPSwitch-GX Minimum Switching Frequency
fSmax			1.40E+05	Hertz	TOPSwitch-GX Maximum Switching Frequency
VOR	99			Volts	Reflected Output Voltage
VDS	10			Volts	TOPSwitch on-state Drain to Source Voltage
VD	0.5			Volts	Output Winding Diode Forward Voltage Drop
VDB	0.7			Volts	Bias Winding Diode Forward Voltage Drop
KP	0.79				Ripple to Peak Current Ratio (0.4 < KRP < 1.0 : 1.0 < KDP < 6.0)
ENTER TRANSFORMER CORE/CONSTRUCTION VARIABLES					
Core Type	EER28L				
Core		EER28L		P/N:	PC40EER28L-Z
Bobbin		EER28L_BOBBIN		P/N:	BEER-28L-1112CPH
AE			0.814	cm ²	Core Effective Cross Sectional Area
LE			7.55	cm	Core Effective Path Length
AL			2520	nH/T ²	Ungapped Core Effective Inductance
BW			21.8	mm	Bobbin Physical Winding Width
M	0			mm	Safety Margin Width (Half the Primary to Secondary Creepage Distance)
L	1				Number of Primary Layers
NS	2				Number of Secondary Turns
DC INPUT VOLTAGE PARAMETERS					
VMIN			229	Volts	Minimum DC Input Voltage
VMAX			375	Volts	Maximum DC Input Voltage



CURRENT WAVEFORM SHAPE PARAMETERS					
DMAX			0.31		Maximum Duty Cycle
I AVG			0.26	Amps	Average Primary Current
IP			1.39	Amps	Peak Primary Current
IR			1.10	Amps	Primary Ripple Current
IRMS			0.50	Amps	Primary RMS Current
TRANSFORMER PRIMARY DESIGN PARAMETERS					
LP			458	μHenries	Primary Inductance
NP			52		Primary Winding Number of Turns
NB			7		Bias Winding Number of Turns
ALG			169	nH/T ²	Gapped Core Effective Inductance
BM			1501	Gauss	Maximum Flux Density at PO, VMIN (BM<3000)
BP			2565	Gauss	Peak Flux Density (BP<4200)
BAC			593	Gauss	AC Flux Density for Core Loss Curves (0.5 X Peak to Peak)
ur			1860		Relative Permeability of Ungapped Core
LG			0.57	mm	Gap Length (Lg > 0.1 mm)
BWE			21.8	mm	Effective Bobbin Width
OD			0.42	mm	Maximum Primary Wire Diameter including insulation
INS			0.06	mm	Estimated Total Insulation Thickness (= 2 * film thickness)
DIA			0.36	mm	Bare conductor diameter
AWG			28	AWG	Primary Wire Gauge (Rounded to next smaller standard AWG value)
CM			161	Cmils	Bare conductor effective area in circular mils
CMA			321	Cmils/Amp	Primary Winding Current Capacity (200 < CMA < 500)
TRANSFORMER SECONDARY DESIGN PARAMETERS (SINGLE OUTPUT / SINGLE OUTPUT EQUIVALENT)					
Lumped parameters					
ISP			36.24	Amps	Peak Secondary Current
ISRMS			19.45	Amps	Secondary RMS Current
IO			13.64	Amps	Power Supply Output Current
IRIPPLE			13.86	Amps	Output Capacitor RMS Ripple Current
CMS			3889	Cmils	Secondary Bare Conductor minimum circular mils
AWGS			14	AWG	Secondary Wire Gauge (Rounded up to next larger standard AWG value)
DIAS			1.63	mm	Secondary Minimum Bare Conductor Diameter
ODS			10.90	mm	Secondary Maximum Outside Diameter for Triple Insulated Wire
INSS			4.64	mm	Maximum Secondary Insulation Wall Thickness
VOLTAGE STRESS PARAMETERS					
VDRAIN			603	Volts	Maximum Drain Voltage Estimate (Includes Effect of Leakage Inductance)
PIVS			18	Volts	Output Rectifier Maximum Peak Inverse Voltage
PIVB			60	Volts	Bias Rectifier Maximum Peak Inverse Voltage



TRANSFORMER SECONDARY DESIGN PARAMETERS (MULTIPLE OUTPUTS)					
1st output					
VO1	5.0			Volts	Output Voltage
IO1	3.200			Amps	Output DC Current
PO1			16.00	Watts	Output Power
VD1	0.7			Volts	Output Diode Forward Voltage Drop
NS1			3.00		Output Winding Number of Turns
ISRMS1			4.563	Amps	Output Winding RMS Current
IRIPPLE1			3.25	Amps	Output Capacitor RMS Ripple Current
PIVS1			27	Volts	Output Rectifier Maximum Peak Inverse Voltage
CMS1			913	Cmils	Output Winding Bare Conductor minimum circular mils
AWGS1			20	AWG	Wire Gauge (Rounded up to next larger standard AWG value)
DIAS1			0.81	mm	Minimum Bare Conductor Diameter
ODS1			7.27	mm	Maximum Outside Diameter for Triple Insulated Wire
2nd output					
VO2	12.0			Volts	Output Voltage
IO2	0.600			Amps	Output DC Current
PO2			7.20	Watts	Output Power
VD2	1.4			Volts	Output Diode Forward Voltage Drop
NS2			7.05		Output Winding Number of Turns
ISRMS2			0.856	Amps	Output Winding RMS Current
IRIPPLE2			0.61	Amps	Output Capacitor RMS Ripple Current
PIVS2			63	Volts	Output Rectifier Maximum Peak Inverse Voltage
CMS2			171	Cmils	Output Winding Bare Conductor minimum circular mils
AWGS2			27	AWG	Wire Gauge (Rounded up to next larger standard AWG value)
DIAS2			0.36	mm	Minimum Bare Conductor Diameter
ODS2			3.09	mm	Maximum Outside Diameter for Triple Insulated Wire
3rd output					
VO3	18.0			Volts	Output Voltage
IO3	0.500			Amps	Output DC Current
PO3			9.00	Watts	Output Power
VD3	1.4			Volts	Output Diode Forward Voltage Drop
NS3			10.21		Output Winding Number of Turns
ISRMS3			0.713	Amps	Output Winding RMS Current
IRIPPLE3			0.51	Amps	Output Capacitor RMS Ripple Current
PIVS3			91	Volts	Output Rectifier Maximum Peak Inverse Voltage
CMS3			143	Cmils	Output Winding Bare Conductor minimum circular mils
AWGS3			28	AWG	Wire Gauge (Rounded up to next larger standard AWG value)
DIAS3			0.32	mm	Minimum Bare Conductor Diameter
ODS3			2.14	mm	Maximum Outside Diameter for Triple Insulated Wire



9 Performance Data

All measurements performed at room temperature, 60 Hz input frequency.

9.1 Efficiency

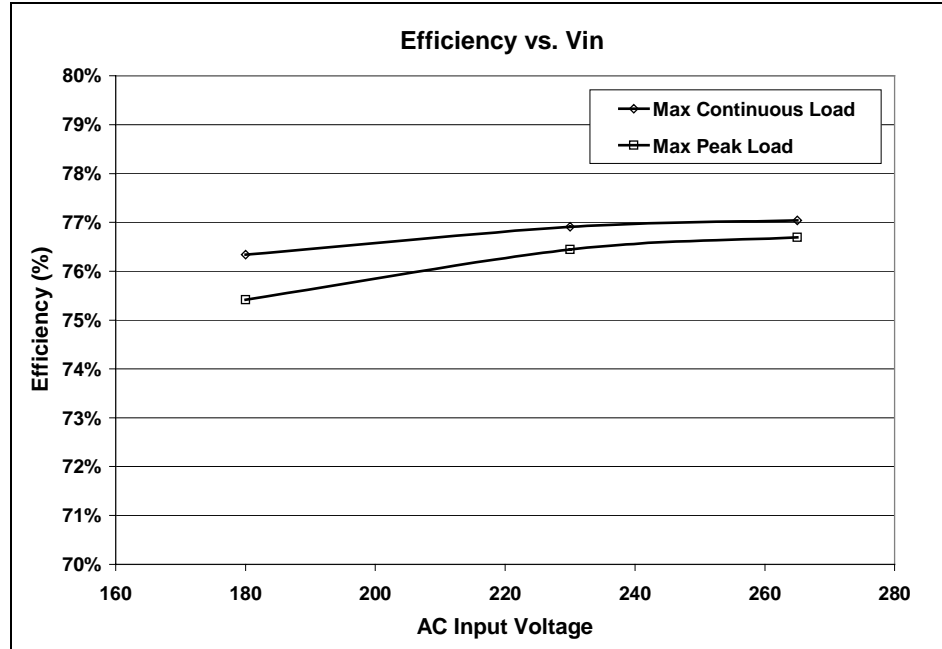

Figure 6 - Efficiency vs. Input Voltage, Full Load, Room Temperature, 60 Hz.

9.2 No-load Input Power

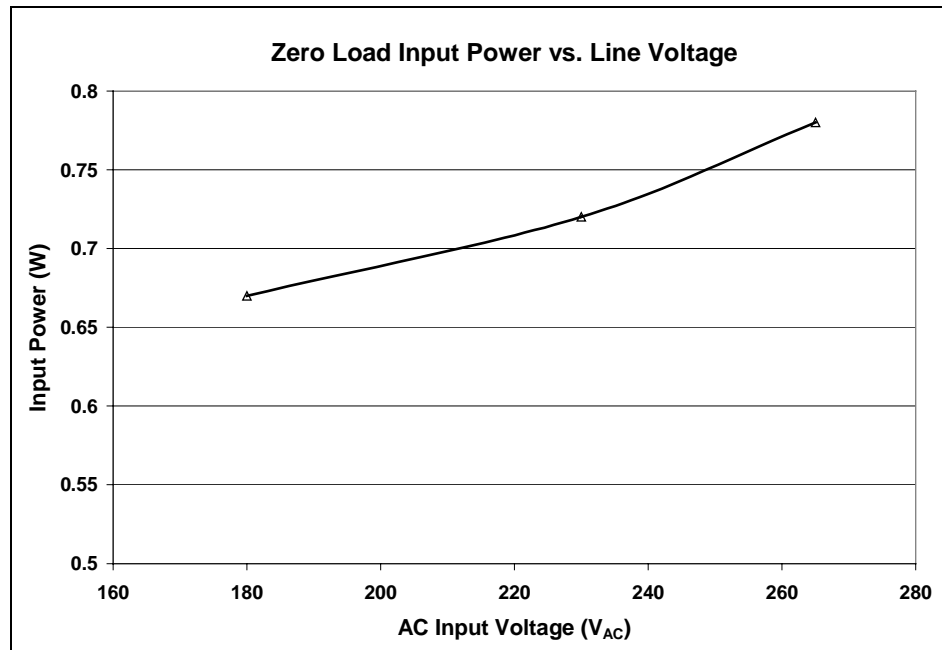

Figure 7 - Zero Load Input Power vs. Input Line Voltage Room Temperature, 60 Hz.



9.3 Regulation

9.3.1 Maximum load all outputs

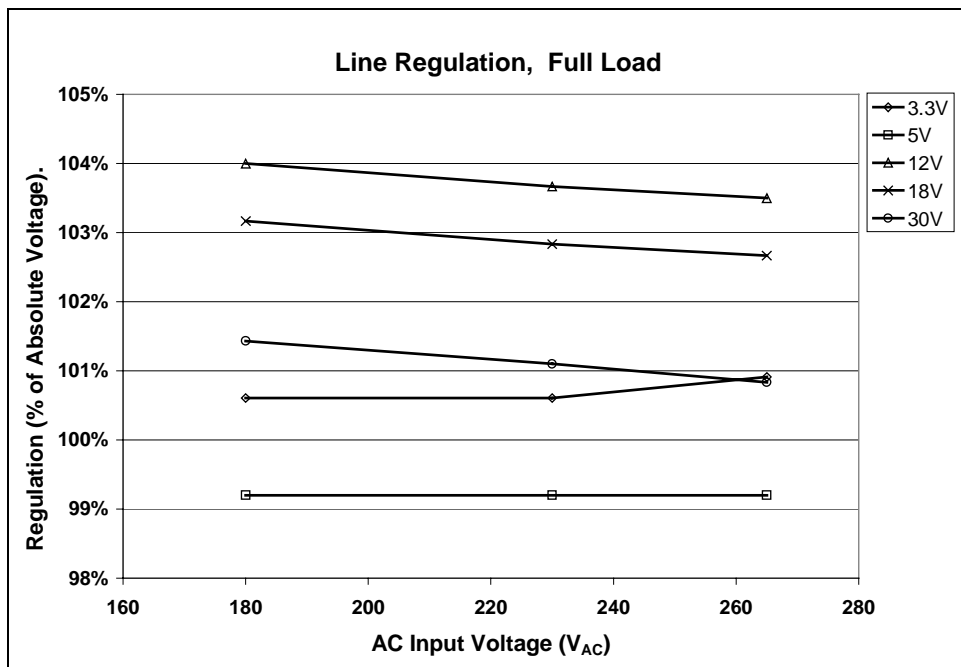

Figure 8 - Line Regulation, Maximum Continuous Load

9.3.2 Peak load all outputs

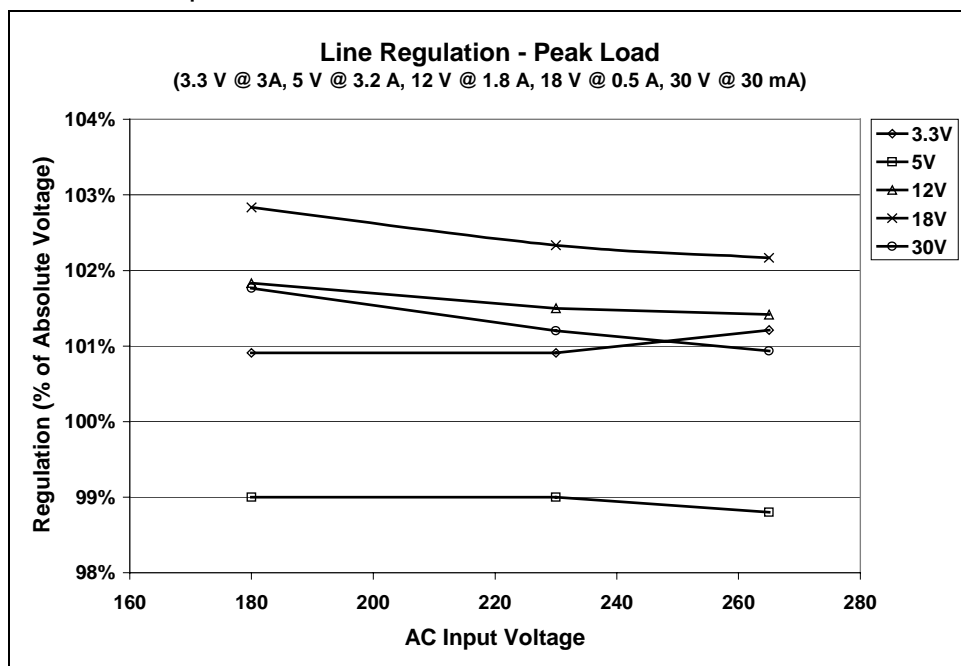

Figure 9 - Line Regulation, Peak Load Condition



9.3.3 3.3 V Min. load, 12 V peak, other outputs fully loaded

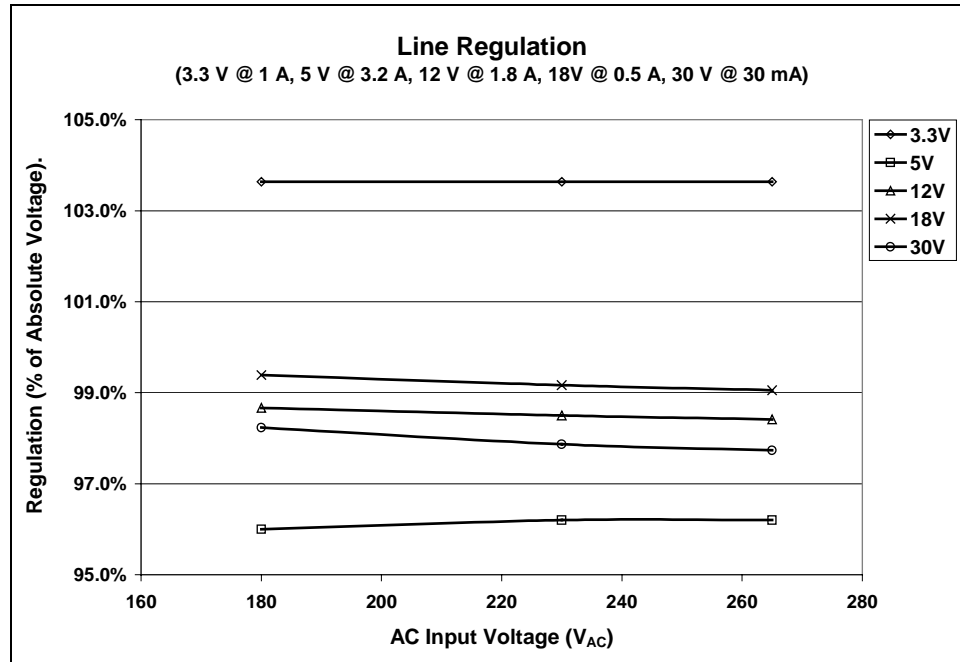

Figure 10 - Line Regulation, 3.3 V @ 1 A, 12 V @ 1.8 A, All Other Outputs Maximum Steady State Load

9.3.4 12 V Min. load, other outputs at maximum load condition

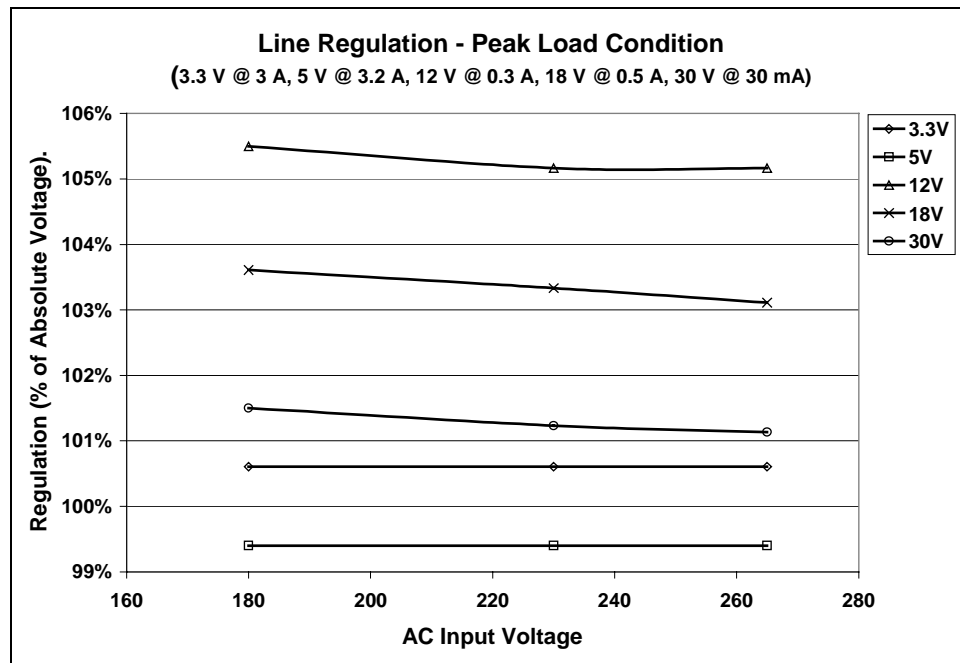

Figure 11 - Line Regulation, 12 V min, and all other outputs maximum load



9.3.5 12 V Peak load, 30 V min. load, other outputs at max. load

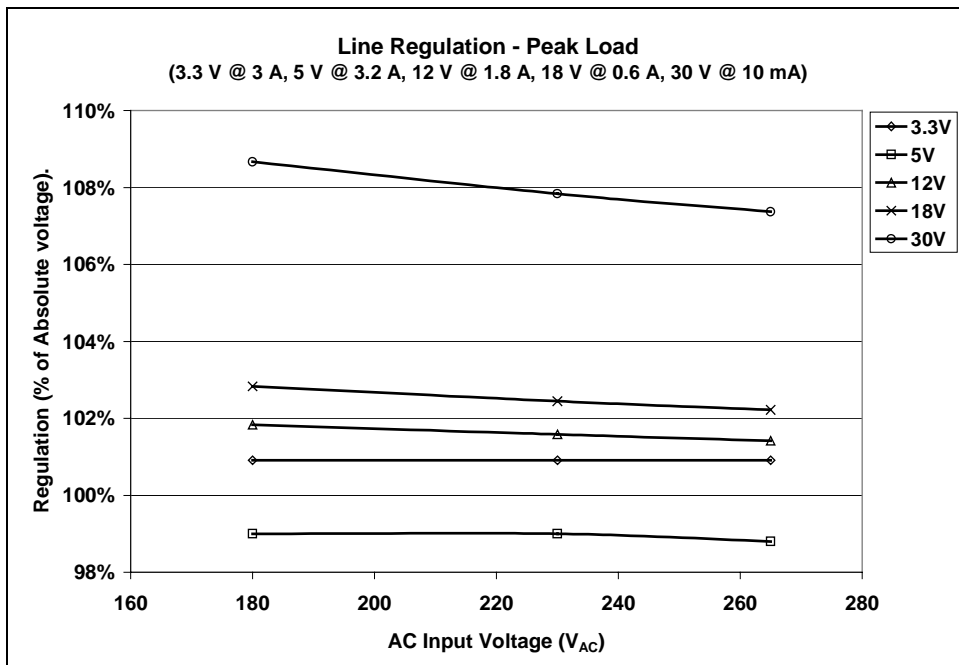

Figure 12 - Line Regulation – 12 V Peak, 30 V Min. Load Condition

9.3.6 5 V and 3.3 V min load, all other outputs maximum

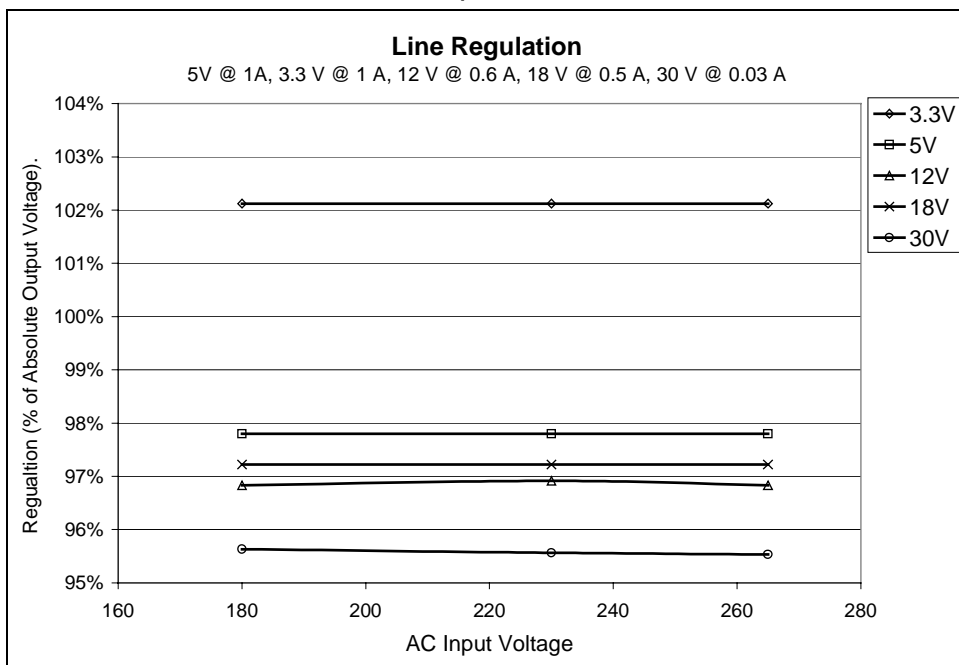

Figure 13 - Line Regulation – 5 V and 3.3 V minimum, other output maximum load



10 Thermal Performance

Item	Temperature			
	180 VAC	230 VAC	180 VAC	230 VAC
Ambient	30.2 °C	31.1 °C	50.9 °C	52 °C
Balun (L1)	41.1 °C	37.8 °C	59.7 °C	55.7 °C
Thermistor (RT1)	78.9 °C	71.3 °C	99.3 °C	90.1 °C
Snubber Resistor (R2)	69.4 °C	69.3 °C	86.4 °C	85.6 °C
Clamp Zener (VR1)	65.9 °C	63.4 °C	85.0 °C	81.2 °C
TOPSwitch (U1)	58.6 °C	59.3 °C	81 °C	79.7 °C
Transformer (T1)	71.2 °C	72.6 °C	94.8 °C	93.7 °C
18V Rectifier (D8)	67.8 °C	68.8 °C	87.3 °C	87.5 °C
12V Rectifier (D9)	74.2 °C	75.1 °C	94.0 °C	93.8 °C
5V Rectifier (D10)	80.3 °C	81.8 °C	102.7 °C	102.5 °C
3.3V Rectifier (D11)	73.7 °C	75 °C	96.1 °C	96.0 °C

Figure 14 - EP13 Thermal Performance

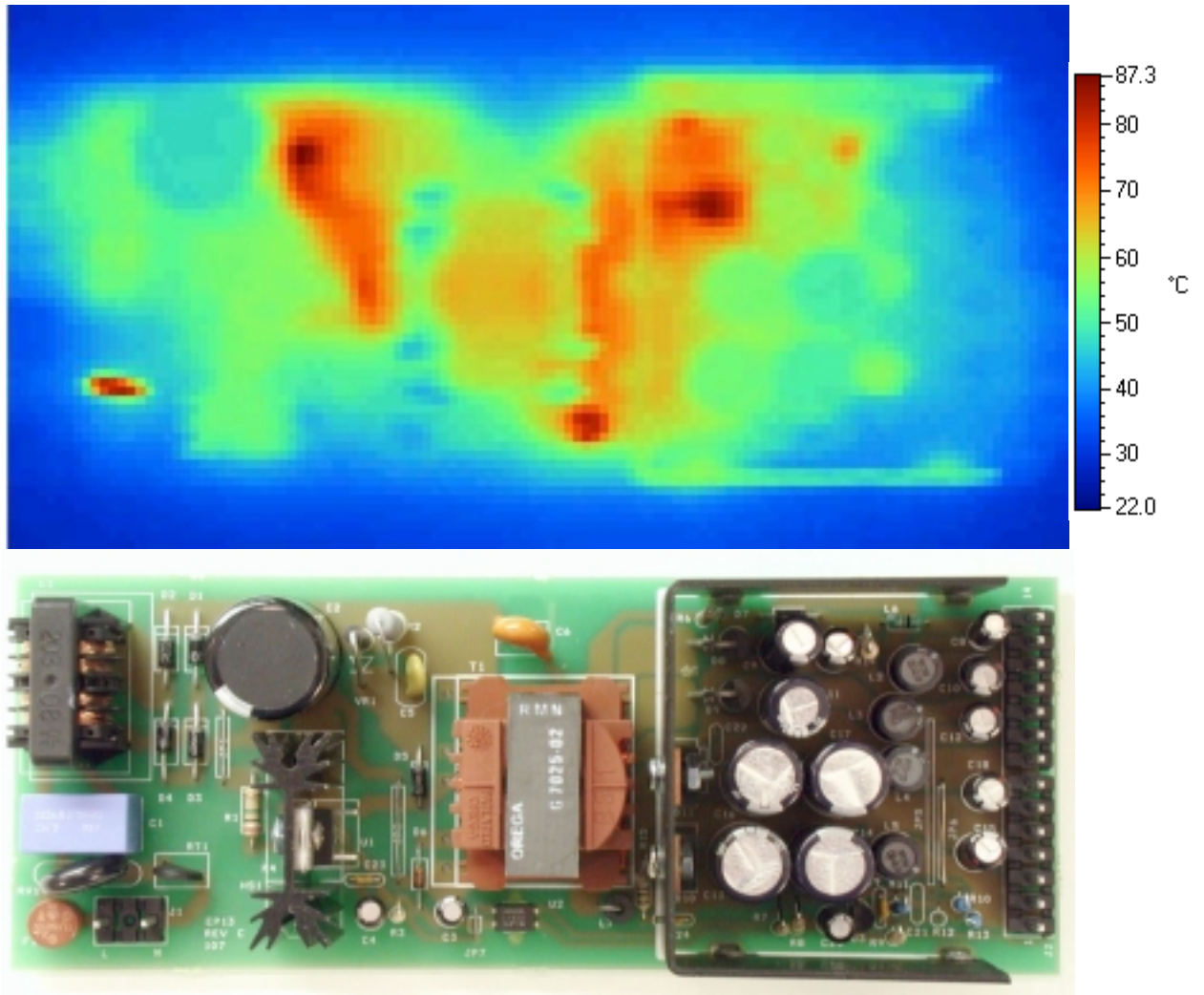

Figure 15 - Infrared Thermograph of EP13, 180 V_{AC} Input, Maximum Continuous Load, 22 °C Ambient. (Board was sprayed black to give an accurate emissivity figure)



11 Waveforms

11.1 Drain Voltage and Current, Normal Operation

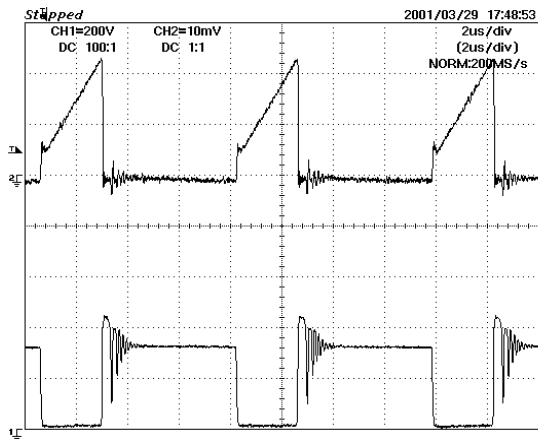

Figure 16 - 180 V_{AC} - Upper: I_{DRAIN}, 0.5 A / div, Lower: V_{DRAIN}, 200 V / div, 2 μs / div

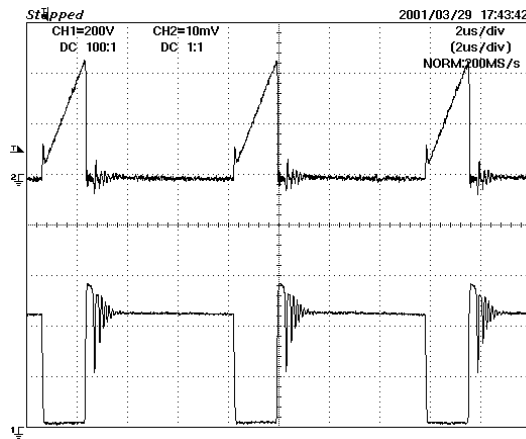

Figure 17 - 265 V_{AC}, Full Load - Upper: I_{DRAIN}, 0.5 A / div, Lower: V_{DRAIN}, 200 V / div, 2 μs / div

11.2 Output Voltage Start-up Profile

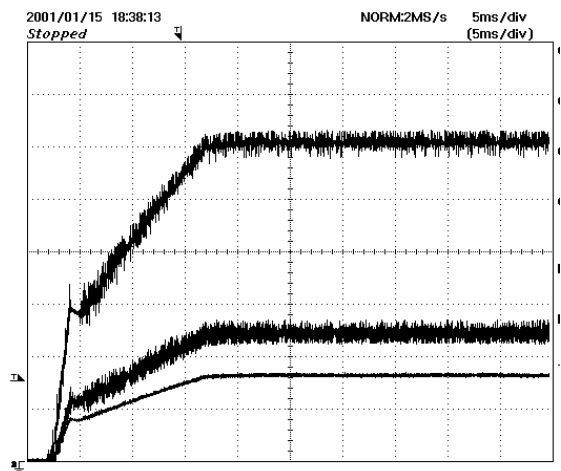

Figure 18 - Start-up Profile, 3.3 V, 5 V and 12 V outputs. 2 V & 5 ms / div.

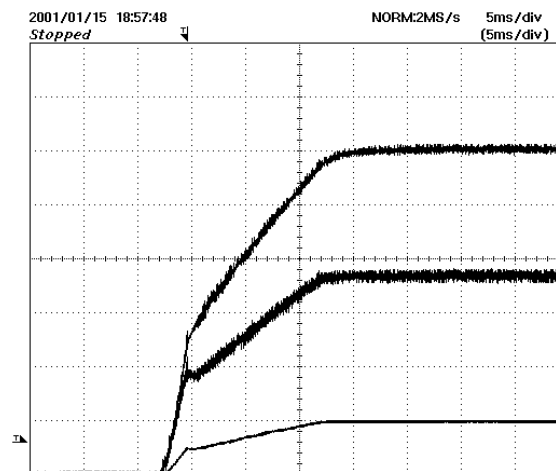

Figure 19 - Start-up Profile, 5 V, 18 V and 30 V outputs. 2 V & 5 ms / div.



11.3 Drain Voltage and Current Start-up Profile

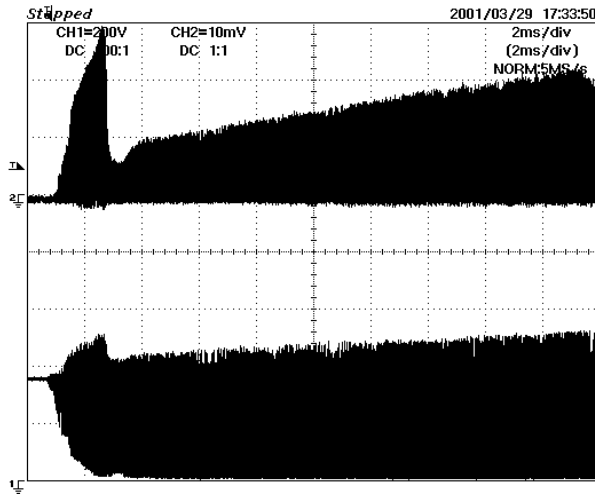

Figure 20 - 180 V_{AC} Input and Maximum Load.
Upper: I_{DRAIN} , 0.5 A / div.
Lower: V_{DRAIN} , 100 V & 2 ms / div.

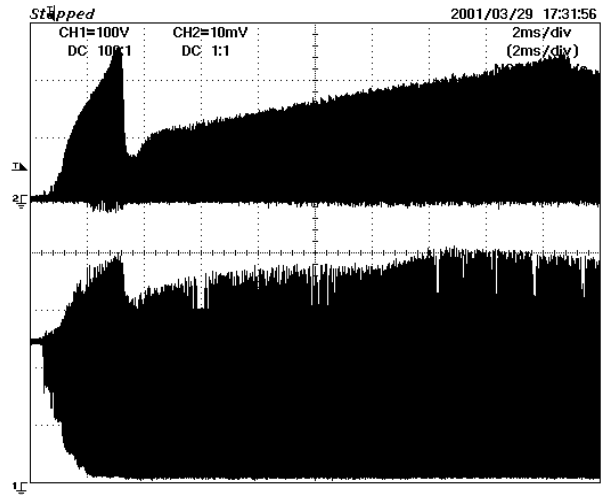

Figure 21 - 265 V_{AC} Input and Maximum Load.
Upper: I_{DRAIN} , 0.5 A / div.
Lower: V_{DRAIN} , 100 V & 2 ms / div.



11.4 Load Transient Response (75% to 100% Load Step)

In the figures shown below, signal averaging was used to better enable viewing the load transient response. The oscilloscope was triggered using the load current step as a trigger source. Since the output switching and line frequency occur essentially at random with respect to the load transient, contributions to the output ripple from these sources will average out, leaving the contribution only from the load step response.

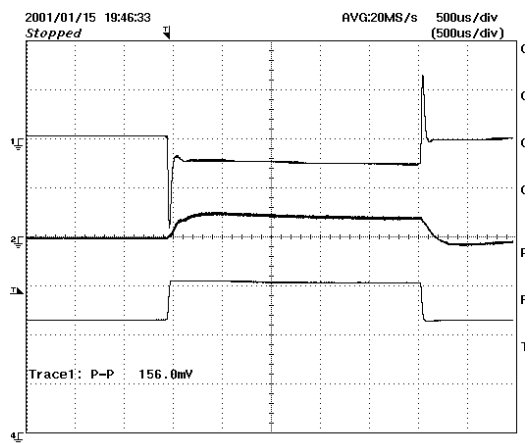

Figure 22 - 5 V and 3.3 V Transient Response.
 75-100-75% Load Step 5 V output.
 Upper: 5 V, 100 mV / div.
 Middle: 3.3 V, 100 mV / div.
 Bottom: 5 V output current, 1 A / div.
 500 μ s / div.

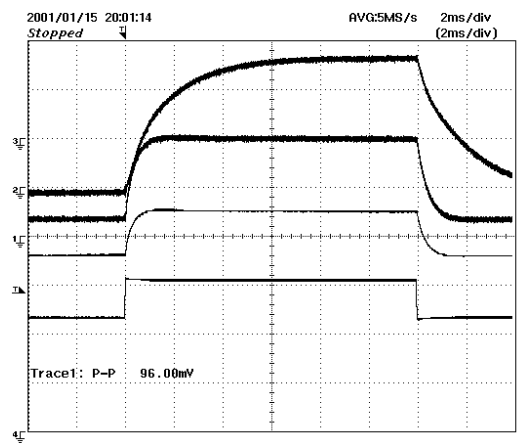

Figure 23 - 12, 18 and 30 V Transient Response.
 75-100-75% Load Step 5 V output.
 Upper: 30 V, 200 mV / div.
 Middle1: 18 V, 200 mV / div.
 Middle2: 12 V, 200 mV / div.
 Bottom: 5 V output current, 1 A / div.
 2 ms / div.



11.5 Output Ripple Measurements

11.5.1 Ripple Measurement Technique

For DC output ripple measurements, a modified oscilloscope test probe must be utilized in order to reduce spurious signals due to pickup. Details of the probe modification are provided in Figure 24 and Figure 25.

The 5125BA probe adapter is affixed with two capacitors tied in parallel across the probe tip. The capacitors include one (1) 0.1 $\mu\text{F}/50\text{ V}$ ceramic type and one (1) 1.0 $\mu\text{F}/50\text{ V}$ aluminum electrolytic. **The aluminum electrolytic type capacitor is polarized, so proper polarity across DC outputs must be maintained (see below).**

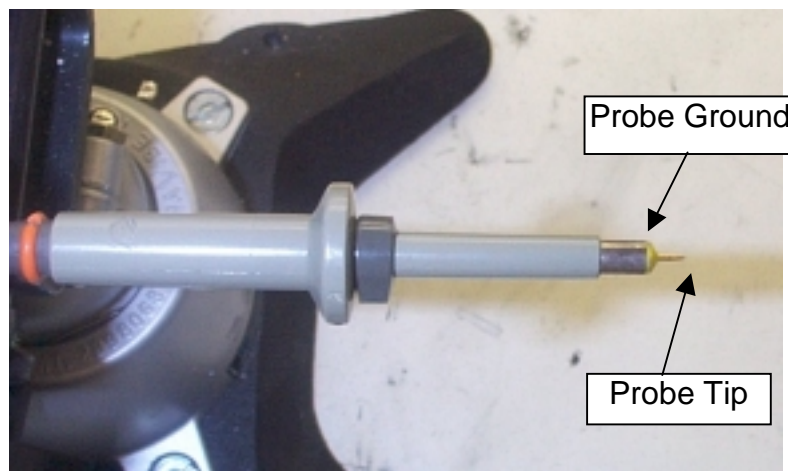

Figure 24 - Oscilloscope Probe Prepared for Ripple Measurement. (End Cap and Ground Lead Removed)



Figure 25 - Oscilloscope Probe with Probe Master 5125BA BNC Adapter. (Modified with wires for probe ground for ripple measurement, and two parallel decoupling capacitors added)

11.5.2 Measurement Results at 180 V_{AC}

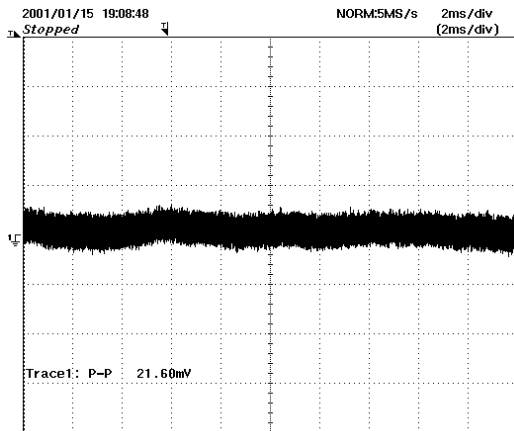

Figure 26 - 3.3 V Ripple, 180 V_{AC}, Full Load.
2 ms, 20 mV / div

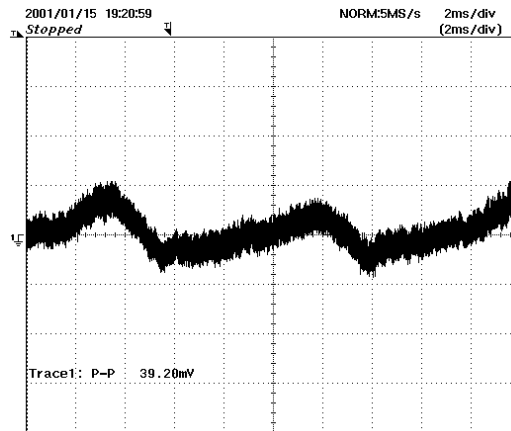

Figure 29 - 18 V Ripple, 180 V_{AC}, Full Load.
2 ms, 20 mV / div

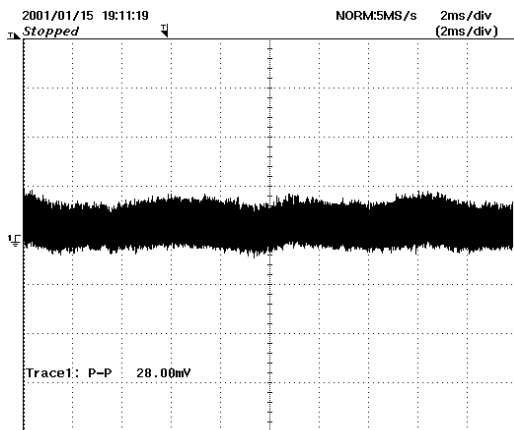

Figure 27 - 5 V Ripple, 180 V_{AC}, Full Load.
2 ms, 20 mV / div

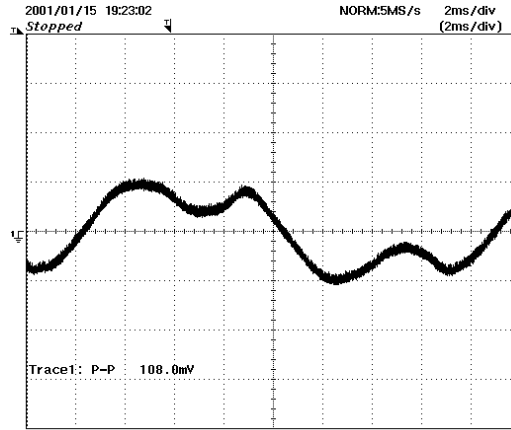

Figure 30 - 33 V Ripple, 180 V_{AC}, Full Load.
2 ms, 20 mV / div

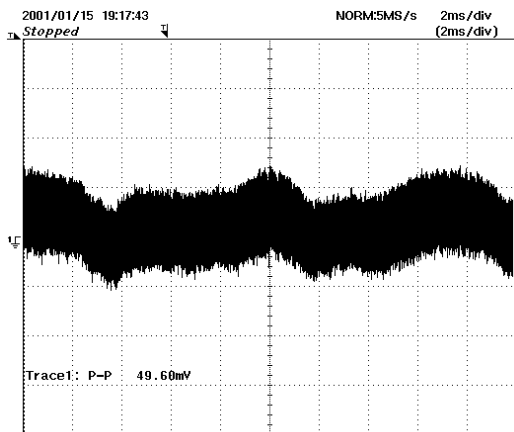

Figure 28 - 12 V Ripple, 180 V_{AC}, Full Load.
2ms, 20 mV / div



11.5.3 Measurement Results at 230 V_{AC}

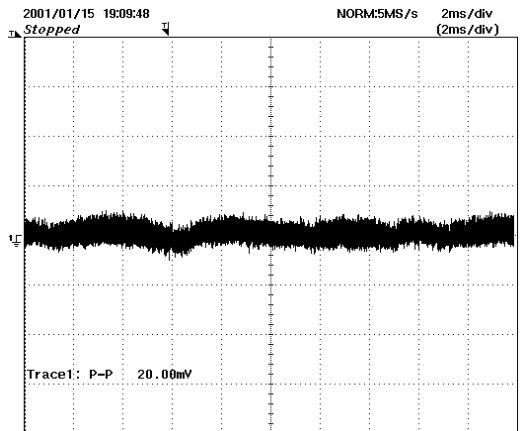

Figure 31 - 3.3 V Ripple, 230 V_{AC}, Full Load.
2 ms, 20 mV / div

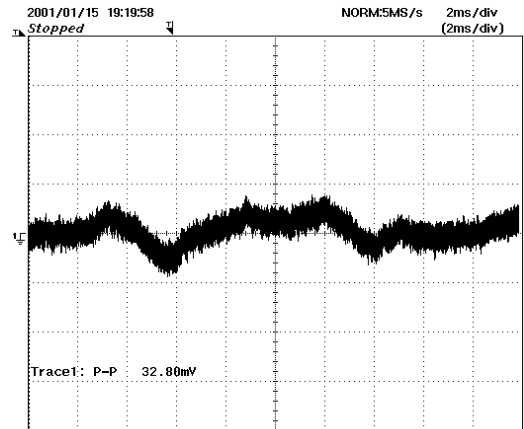

Figure 34 - 18 V Ripple, 230 V_{AC}, Full Load.
2 ms, 20 mV / div

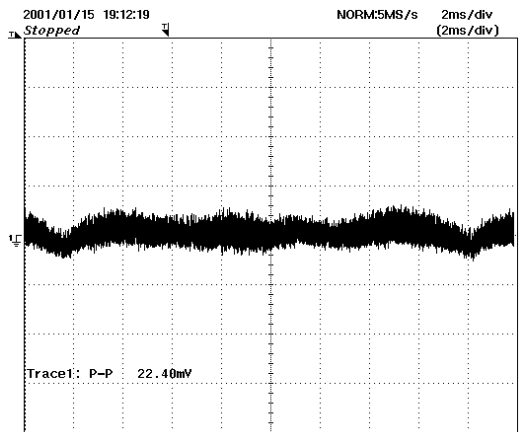

Figure 32 - 5 V Ripple, 230 V_{AC}, Full Load.
2 ms, 20 mV / div

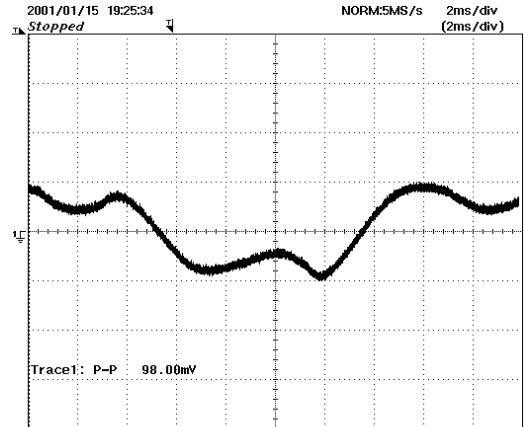

Figure 35 - 18 V Ripple, 230 V_{AC}, Full Load.
2 ms, 20 mV / div

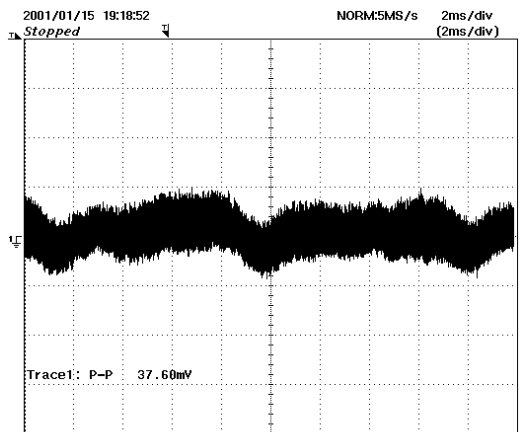

Figure 33 - 12 V Ripple, 230 V_{AC}, Full Load.
2 ms, 20 mV / div



12 Control Loop Measurements

12.1 180 V_{AC} Maximum Load

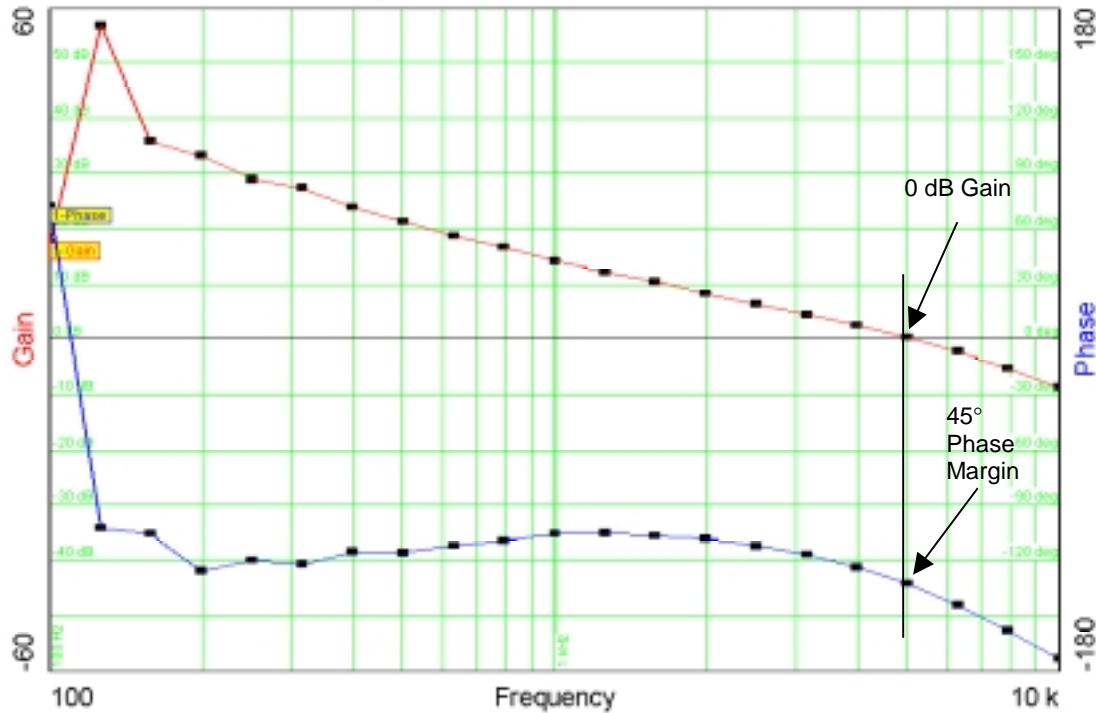

Figure 36 - Gain-Phase Plot, 180 VAC, Maximum Steady State Load
 Vertical Scale: Gain = 10 dB/div, Phase = 30 °/div.



12.2 230 V_{AC} Maximum Load

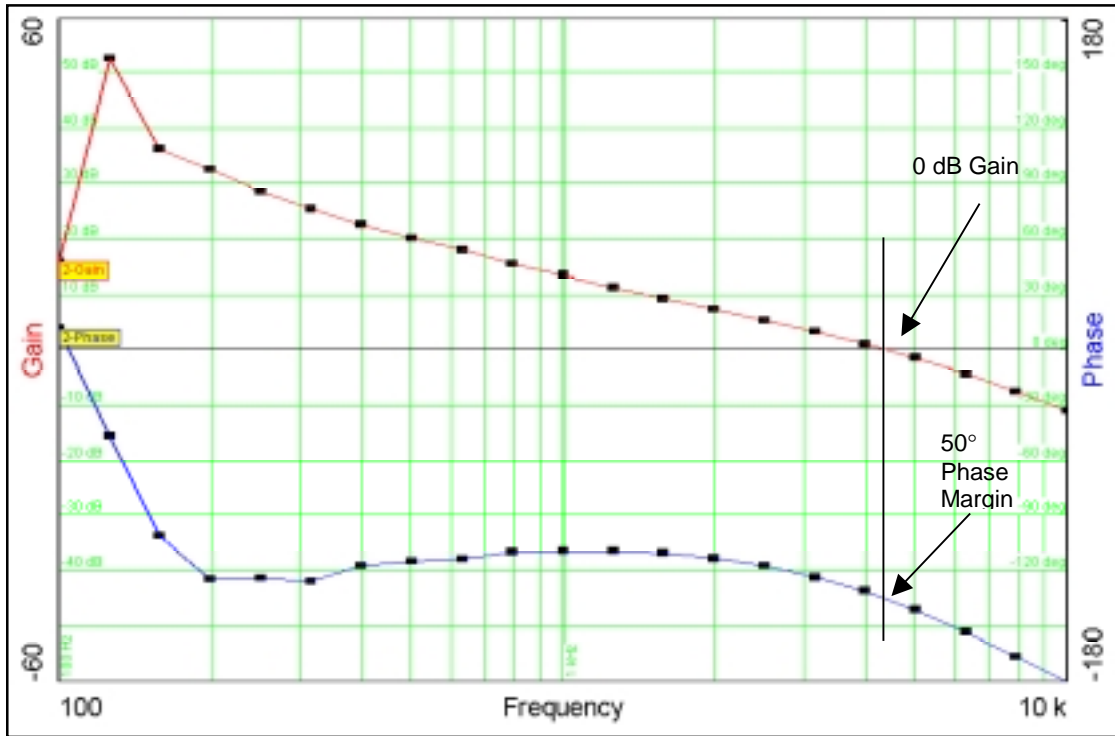

Figure 37 - Gain-Phase Plot, 230 V_{AC}, Maximum Steady State Load
Vertical Scale: Gain = 10 dB/div, Phase = 30 °/div.



12.3 265 V_{AC} Maximum Load

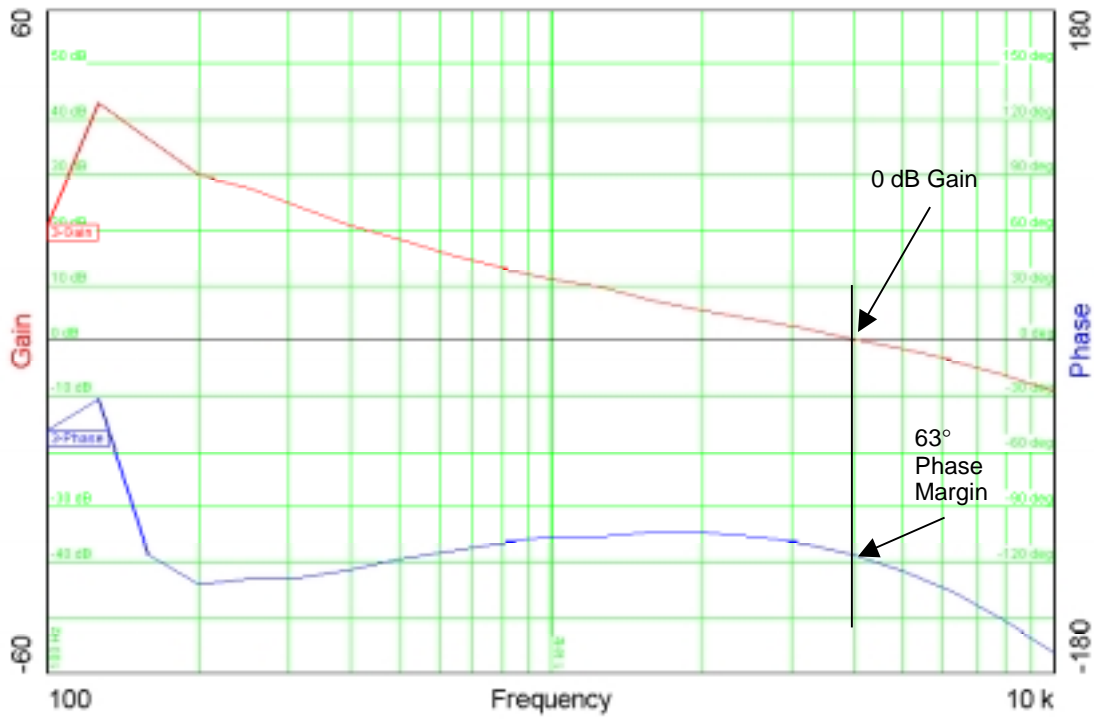

Figure 38 - Gain-Phase Plot, 265 V_{AC}, Maximum Steady State Load
Vertical Scale: Gain = 10 dB/div, Phase = 30 °/div.



13 Conducted EMI

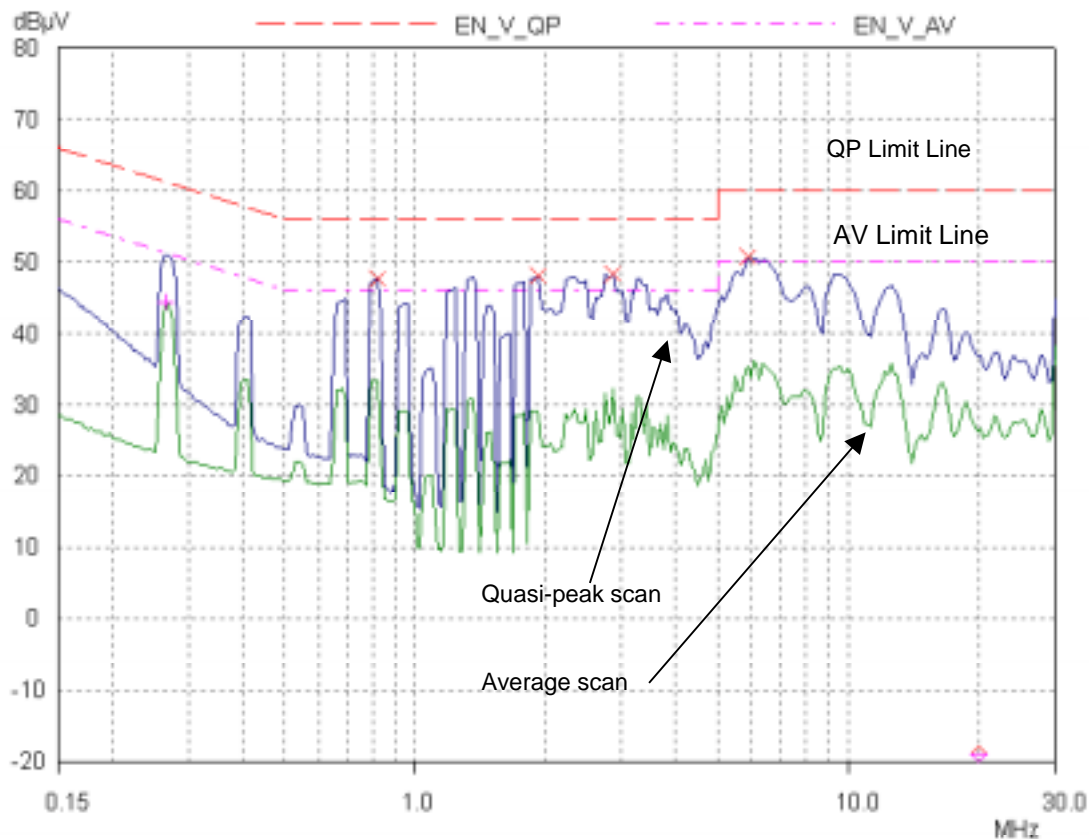

Figure 39 - Conducted EMI, Maximum Steady State Load, 230 V_{AC}, 60 Hz, and EN55022 B Limits.

14 AC Surge and 100 kHz Ring Wave Immunity

Four series of line transient tests were performed on the EP13 to determine the level of immunity attainable for the basic board. Testing was performed using a Keytek EMC Pro surge generator. The input voltage for the supply under test was 230 V_{AC}, and the supply was loaded to the maximum continuous output power using resistive loads on each output. An LED was used to monitor the presence of output voltage and to detect output interruptions. Test for each series was terminated upon non-destructive interruption of output voltage, arcing, or non-recoverable interruption of output voltage. A test failure was defined as a non-recoverable interruption of output voltage requiring supply repair or recycling of input AC voltage.



14.1 Common Mode Surge, 1.2/50 μ sec

Surge Voltage	Phase Angle (°)	Generator Impedance	Number of Strikes	Test Result
1 kV	0	12 ohms	10	PASS
1 kV	90	12 ohms	10	PASS
1 kV	270	12 ohms	10	PASS
1.5 kV	0	12 ohms	10	PASS
1.5 kV	90	12 ohms	10	PASS
1.5 kV	270	12 ohms	10	PASS
2 kV	0	12 ohms	10	PASS
2 kV	90	12 ohms	10	PASS
2 kV	270	12 ohms	10	PASS
2.5 kV	0	12 ohms	10	PASS
2.5 kV	90	12 ohms	10	PASS
2.5 kV	270	12 ohms	10	PASS
3 kV	0	12 ohms	10	PASS
3 kV	90	12 ohms	10	PASS
3 kV	270	12 ohms	10	PASS
3.5 kV	0	12 ohms	10	PASS
3.5 kV	90	12 ohms	10	PASS
3.5 kV	270	12 ohms	10	PASS
4 kV	0	12 ohms	10	PASS
4 kV	90	12 ohms	10	PASS
4 kV	270	12 ohms	1	PASS (board arcing, supply still operational)

14.2 Differential Mode Surge, 1.2/50 μ sec

Surge Voltage	Phase Angle (°)	Generator Impedance	Number of Strikes	Test Result
1 kV	0	12 ohms	10	PASS
1 kV	90	12 ohms	10	PASS
1 kV	270	12 ohms	10	PASS
1.5 kV	0	12 ohms	10	PASS
1.5 kV	90	12 ohms	10	PASS
1.5 kV	270	12 ohms	10	PASS
2 kV	0	12 ohms	10	PASS
2 kV	90	12 ohms	10	PASS
2 kV	270	12 ohms	10	PASS
2.5 kV	0	12 ohms	10	PASS
2.5 kV	90	12 ohms	10	PASS
2.5 kV	270	12 ohms	10	PASS
3 kV	0	12 ohms	10	PASS
3 kV	90	12 ohms	10	PASS
3 kV	270	12 ohms	10	PASS
3.5 kV	0	12 ohms	10	PASS
3.5 kV	90	12 ohms	10	PASS
3.5 kV	270	12 ohms	10	PASS
4 kV	0	12 ohms	10	PASS
4 kV	90	12 ohms	1	PASS (output interruption, board still functional)



14.3 Common Mode, 100 kHz Ring Wave

Surge Voltage (kV)	Phase Angle (°)	Short Circuit Current	Number of Strikes	Test Result
1 kV	0	500 A	10	PASS
1 kV	90	500 A	10	PASS
1 kV	270	500 A	10	PASS
2 kV	0	500 A	10	PASS
2 kV	90	500 A	10	PASS
2 kV	270	500 A	10	PASS
3 kV	0	500 A	10	PASS
3 kV	90	500 A	10	PASS
3 kV	270	500 A	10	PASS
4 kV	0	500 A	10	PASS
4 kV	90	500 A	10	PASS
4 kV	270	500 A	10	PASS
4.5 kV	0	500 A	10	PASS
4.5 kV	90	500 A	10	PASS
4.5 kV	270	500 A	10	PASS
5 kV	0	500 A	10	PASS
5 kV	90	500 A	10	PASS
5 kV	270	500 A	10	PASS
5.5 kV	0	500 A	10	PASS
5.5 kV	90	500 A	10	PASS
5.5 kV	270	500 A	10	PASS
6 kV	0	500 A	1	FAIL*

* U1 failure

14.4 Differential Mode, 100 kHz Ring Wave

Surge Voltage	Phase Angle (°)	Short Circuit Current	Number of Strikes	Test Result
3 kV	0	500 A	10	PASS
3 kV	90	500 A	10	PASS
3 kV	270	500 A	10	PASS
4 kV	0	500 A	10	PASS
4 kV	90	500 A	10	PASS
4 kV	270	500 A	10	PASS
4.5 kV	0	500 A	10	PASS
4.5 kV	90	500 A	10	PASS
4.5 kV	270	500 A	10	PASS
5 kV	0	500 A	10	PASS
5 kV	90	500 A	10	PASS
5 kV	270	500 A	10	PASS
5.5 kV	0	500 A	10	PASS
5.5 kV	90	500 A	10	PASS
5.5 kV	270	500 A	10	PASS
6 kV	0	500 A	10	PASS
6 kV	0	500 A	10	PASS
6 kV	0	500 A	10	PASS



15 Appendix A – EP13, 115 V_{AC} Version

A kit of parts is included in the DAK-13 to convert the EP13 supply from 230 V to 115 V operation. The EP13 printed circuit board is designed to accommodate these changes without modification, so that only a stuffing change is required. Specification, schematic, and modification information for the EP13 115 V version are shown below.

15.1 115 VAC Option Power Supply Specification

Description	Symbol	Min	Typ	Max	Units	Comment
Input Voltage		85		132	VAC	2 Wire
Output						
Output Voltage 1	V _{OUT1}	3.14	3.30	3.46	V	+/-5%
Output Ripple Voltage 1	V _{RIPPLE1}			33	mV	20 MHz BW
Output Current 1	I _{OUT}	1.0	3.00	3.00	A	
Output Voltage 2	V _{OUT2}	4.75	5.00	5.25	V	+/-5%
Output Ripple Voltage 2	V _{RIPPLE2}			50	mV	20 MHz BW
Output Current 2	I _{OUT}	1.00	3.20	3.20	A	
Output Voltage 3	V _{OUT3}	11.16	12.0	12.84	V	+/-7%
Output Ripple Voltage 3	V _{RIPPLE3}			120	mV	20 MHz BW
Output Current 3	I _{OUT}	0.30	0.60	1.8*	A	*Peak load, 10 sec max.
Output Voltage 4	V _{OUT4}	16.74	18.00	19.26	V	+/-7%
Output Ripple Voltage 4	V _{RIPPLE4}			180	mV	20 MHz BW
Output Current 4	I _{OUT}	0.5	-	0.5	A	
Output Voltage 5	V _{OUT5}	27	33	32.4	V	+/-10%
Output Ripple Voltage 5	V _{RIPPLE5}			200	mV	20 MHz BW
Output Current 5	I _{OUT}	0.01	-	0.03	A	
Total Output Power						
Continuous Output Power	P _{OUT_TOTAL}			43	W	
Peak Output Power				57		
Efficiency	η	75%			%	@ maximum continuous load
Environmental						
Conducted EMI						Meets CISPR22B/EN55022B
Safety						Designed to meet IEC950, UL1950 Class II
Ambient Temperature		0 °C		50 °C	°C	Free convection, sea level

Table 1 - EP13 115 V_{AC} Option Specification



15.2 Schematic for EP13 115 V_{AC}-only Version

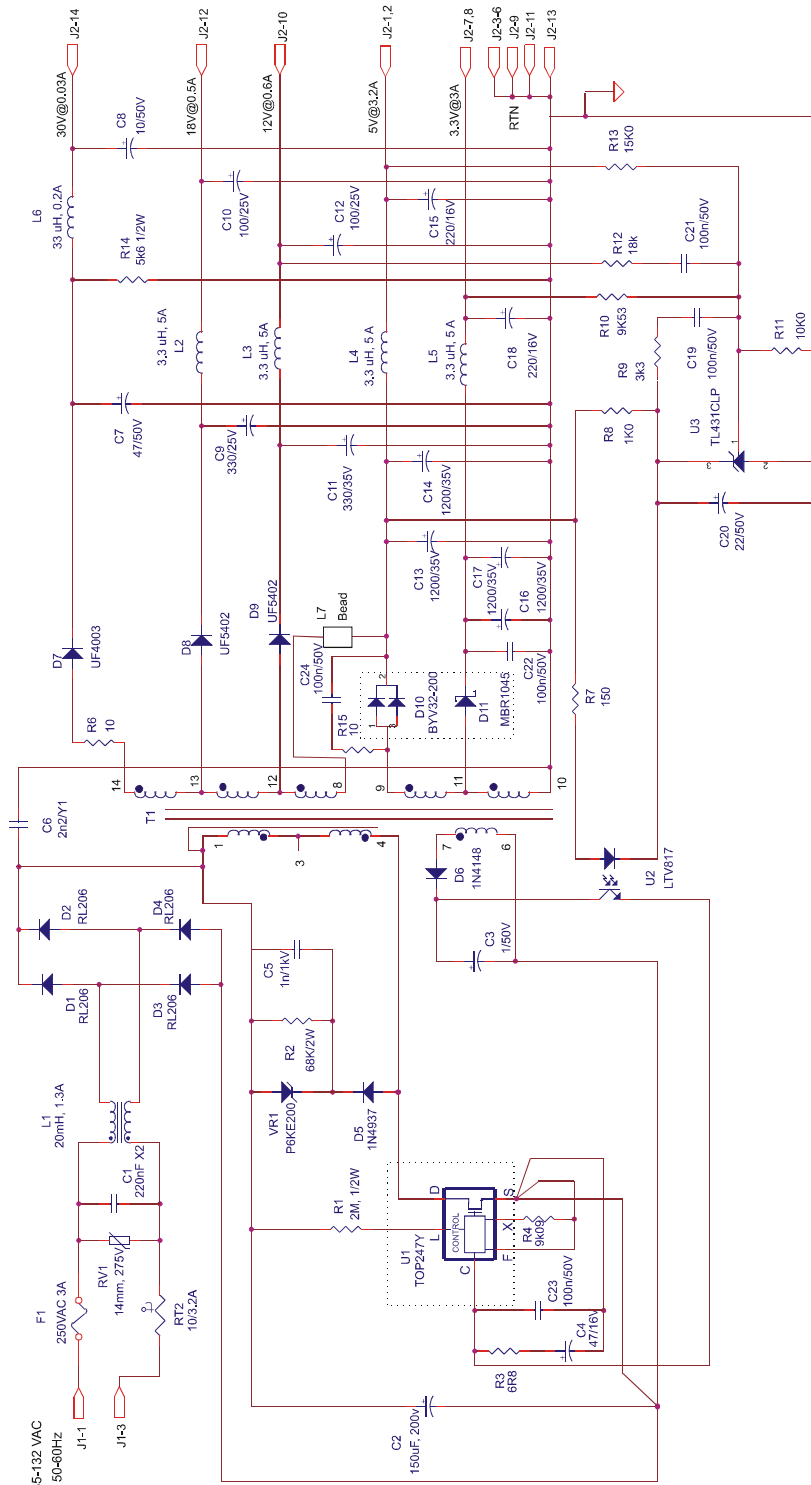

Figure 40 - Schematic for EP13 115 V_{AC} only Version



15.3 EP13 115 V_{AC} Version Circuit Description

The circuit shown in the schematic of Figure 38 is a 115 VAC-only version of the EP13. Several notable changes were made in the circuit to accommodate 115 VAC-only operation. C2 is changed from 68 μ F, 400 V to 150 μ F, 200 V. RT1, D1-4, and L1 were changed to devices with higher current rating to accommodate the increased current draw at 115 VAC. U1 is changed from a TOP246Y to a TOP247Y, which has a higher current rating.

Since the 115 VAC-only supply runs at a higher primary peak and RMS current, the secondary RMS currents are correspondingly higher. To handle the increased secondary RMS ripple current, the filter capacitors in the 5 V and 3.3 V outputs (C13-14 and C16-17) are changed to devices with a higher ripple current rating.

R12 and C21 have been added on the secondary voltage control to inject AC ripple information from the 12 V output into the control circuit. This “ripple steering” circuit reduces the 12 V output ripple, especially at low AC input voltage.

T1 is replaced with a conventional margin-wound ERL28 transformer, since the multiple section transformer used in the 230 VAC version of the EP13 cannot handle the higher primary and secondary currents present at lower input voltages. The 5 V and 3.3 V secondaries in this transformer are wound using copper foil to reduce resistive losses and improve cross regulation.



15.4 EP13 115 V_{AC} Transformer Drawing

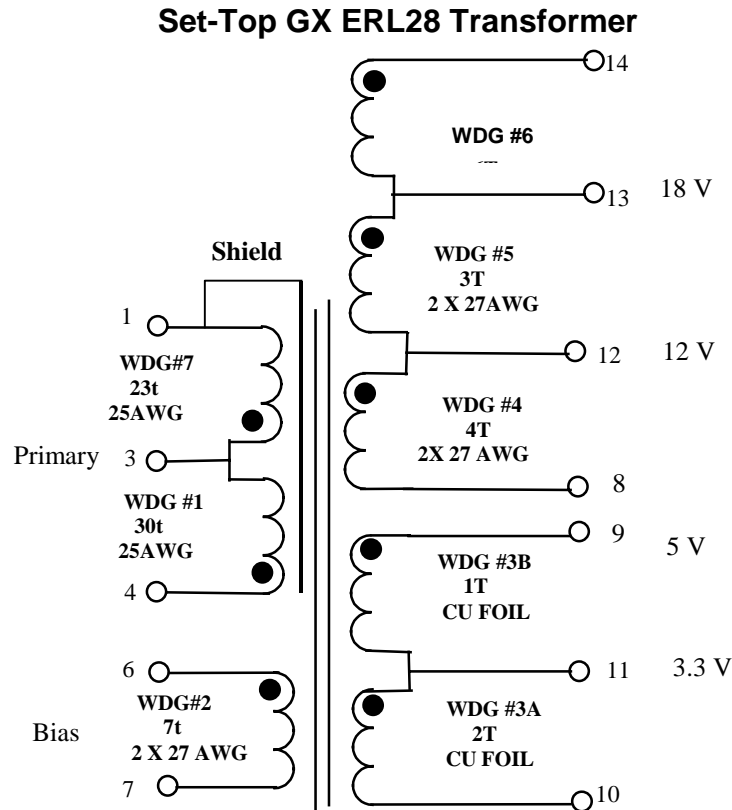

15.5 Electrical Specifications

Electrical strength	60 Hz 1 minute, from Pins 1-7 to Pins 8-14	3000 VAC
Primary Inductance	Pins 1-4, All other windings open, 100 kHz	356 μH
Resonant Frequency	Pins 1-4, All other windings open	1.1 MHz
Primary leakage inductance	Pins 1-4, Pins 8-12 shorted, 100 kHz	<11 μH



15.6 Materials

Item	Description
[1]	Core: ERL28, Nippon Ceramic NC-2H material or equivalent Gap for A_L of 128 nH/t ²
[2]	Bobbin: ERL28 vertical, 14 pins, Jinbo Industrial JB-0039 or equivalent
[3]	Magnet Wire: #25 AWG solderable double coated
[4]	Magnet Wire: #27 AWG solderable double coated
[5]	Copper foil 0.60" x .005"
[6]	Copper foil 0.60" x .001"
[7]	Tinned bus wire, 22 AWG
[8]	Tape: 3M Type 1298 polyester film or equiv. 22.4 mm wide
[9]	Tape: 3M Type 1298 polyester film or equiv. 16 mm wide
[10]	Tape: 3M Type 44. polyester web or equiv. 3.2 mm wide (min)
[11]	Transformer Varnish

15.7 Transformer Construction Diagram

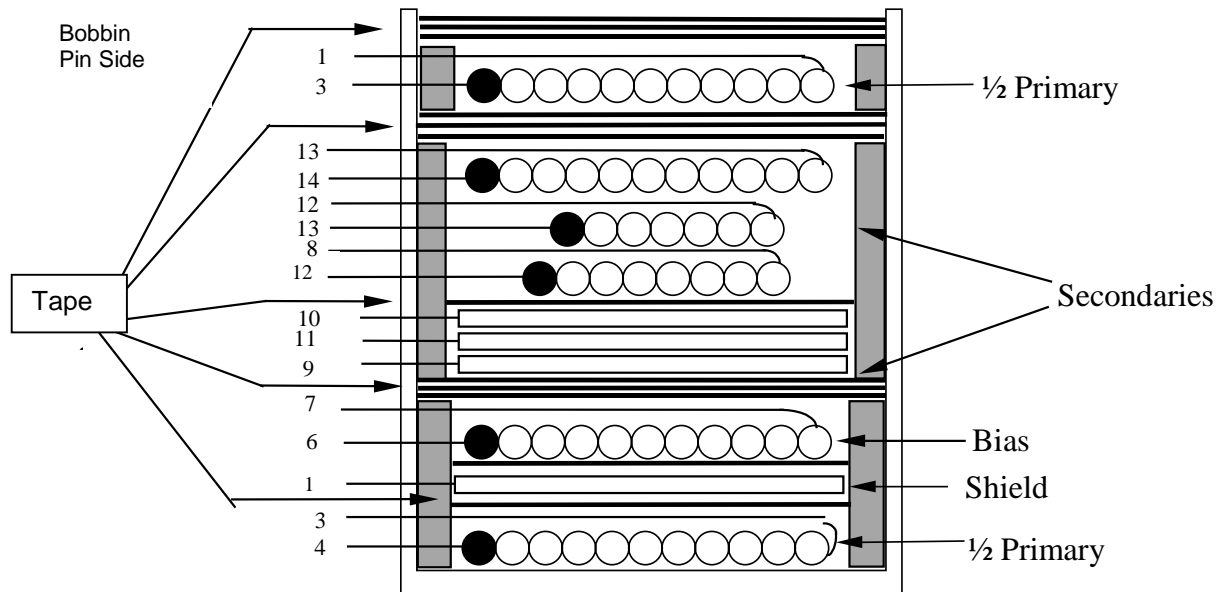

15.8 Winding Instructions

Bobbin Preparation	Remove pins 2 and 5 on bobbin.
Margin Taping	Apply a 3.2 mm margin at each side of bobbin using item [10]. Match combined height of 1 st primary, shield and bias windings.
1 st Primary Winding	Start at pin 4. Wind 30 turns of item [3] uniformly across the bobbin in one layer. Finish at pin 3.
Basic Insulation	Apply one layer of tape [9] for basic insulation.
Shield	Prepare shield assembly using items [4] and [6]. Position shield assembly so that termination wire is adjacent to pin 1. Wrap foil around bobbin, and insulate between overlapping foil ends using tape [9]. Terminate drain wire at pin 1.
Basic Insulation	Apply one layer of tape [9] for basic insulation.
Bifilar Bias Winding	Start at pin 6. Wind 7 bifilar turns of item [4] uniformly in a single layer, across entire width of bobbin. Finish on pin 7.
Reinforced Insulation	Apply three layers of tape [8] for reinforced insulation.
Margin Taping	Apply a 3.2 mm margin at each side of bobbin using item [10]. Match combined height of secondary windings.
Copper Foil Winding	Prepare cuffed foil assembly as shown below, using items [5], [7], [8], and [9]. Start foil winding at pin 9. Wind 1 turn and terminate tap at pin 11. Wind 2 additional turns and finish at pin 10.
Basic Insulation	Apply one layer of tape [9] for basic insulation.
+12 V Bifilar Winding	Starting at pin 12, wind 4 bifilar turns of item [4] evenly across bobbin. Finish at pin 8.
+18 V Bifilar Winding	Starting at pin 13, wind 3 bifilar turns of item [4] directly over the 12 V winding. Apply turns evenly across bobbin. Finish at Pin 12.
+30V Winding	Starting at pin 14, wind 6 turns of item [4] directly over the 18 V winding. Apply turns evenly across bobbin. Finish at Pin 13.
Reinforced Insulation	Apply three layers of tape [8] for reinforced insulation.
Margin Taping	Apply a 3.2 mm margin at each side of bobbin using item [10]. Match height of 2 nd primary winding.
2 nd Primary Winding	Start at pin 3. Wind 23 turns of item [3] uniformly across the bobbin in one layer. Finish at pin 1.
Outer Insulation	Apply 3 Layers of tape [8] for outer insulation
Varnish	Impregnate transformer using item [11]



15.8.1 Shield Foil Assembly

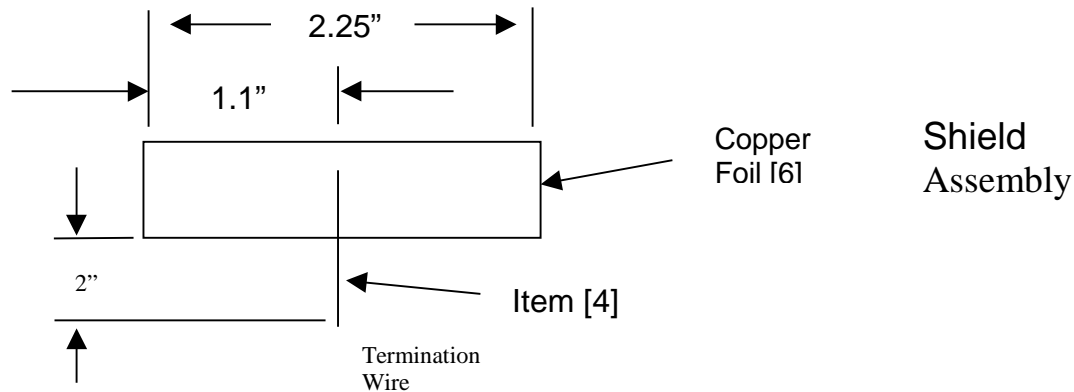

15.8.2 Secondary Foil Assembly

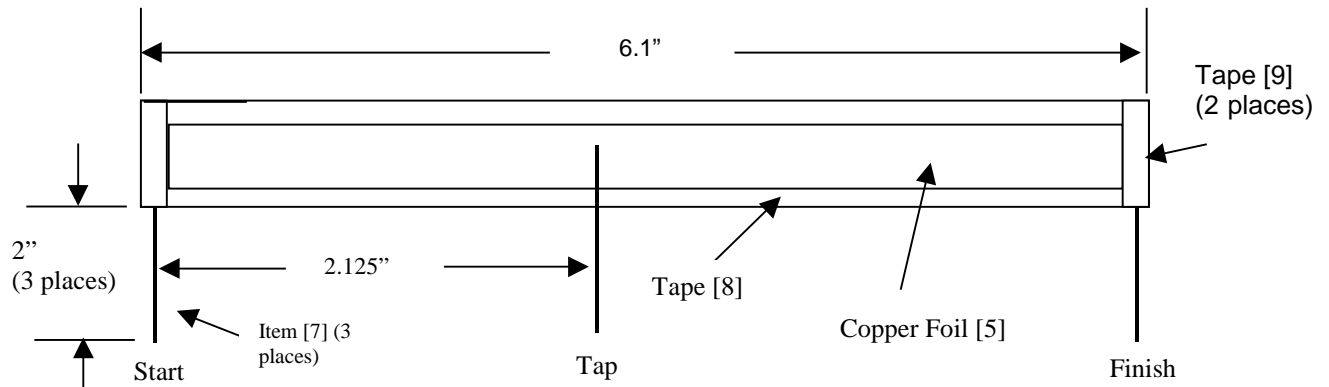

Secondary Foil Assembly

15.8.3 Design Notes

Power Integrations Device	TOP247
Frequency of Operation	132 kHz
Mode	Continuous
Peak Current	1.71 Amps
Reflected Voltage (Secondary to Primary)	100 V
Maximum DC Input Voltage	187 VDC
Minimum DC Input Voltage	93 VDC



15.9 EP13 115 V_{AC} Transformer Spreadsheets

15.9.1 115 V_{AC}, 60 W Peak Load

ACDC_TOPGX_Rev1.1_040401 Copyright Power Integrations Inc. 2000	INPUT	INFO	OUTPUT	UNIT	TOP_GX_040401.xls: TOPSwitch-GX Continuous/Discontinuous Flyback Transformer Design Spreadsheet
ENTER APPLICATION VARIABLES					Customer
VACMIN	85			Volts	Minimum AC Input Voltage
VACMAX	132			Volts	Maximum AC Input Voltage
fL	50			Hertz	AC Mains Frequency
VO	3.3			Volts	Output Voltage
PO	60			Watts	Output Power
n	0.7				Efficiency Estimate
Z	0.5				Loss Allocation Factor
VB	12			Volts	Bias Voltage
tC	3			mSeconds	Bridge Rectifier Conduction Time Estimate
CIN	150			μFarads	Input Filter Capacitor
ENTER TOPSwitch-GX VARIABLES					
TOP-GX	TOP247			Universal	115 Doubled/230 V
Chosen Device		TOP247	Power Out	105 W	200 W
KI	0.8				External ILIMIT reduction factor (KI=1.0 for default ILIMIT, KI <1.0 for lower ILIMIT)
ILIMITMIN			2.592	Amps	Use 1% resistor in setting external ILIMIT
ILIMITMAX			3.168	Amps	Use 1% resistor in setting external ILIMIT
Frequency - (F)=130 kHz, (H)=65 kHz	f				Full (F) frequency option - 130 kHz
fS	130000		1.30E+05	Hertz	TOPSwitch-GX Switching Frequency: Choose between 130 kHz and 65 kHz
fSmin			1.24E+05	Hertz	TOPSwitch-GX Minimum Switching Frequency
fSmax			1.40E+05	Hertz	TOPSwitch-GX Maximum Switching Frequency
VOR	100			Volts	Reflected Output Voltage
VDS	10			Volts	TOPSwitch on-state Drain to Source Voltage
VD	0.5			Volts	Output Winding Diode Forward Voltage Drop
VDB	0.7			Volts	Bias Winding Diode Forward Voltage Drop
KP	0.40				Ripple to Peak Current Ratio (0.4 < KRP < 1.0 : 1.0 < KDP < 6.0)
ENTER TRANSFORMER CORE/CONSTRUCTION VARIABLES					
Core Type	EER28L				
Core		EER28L		P/N:	PC40EER28L-Z
Bobbin		EER28L_BOBBIN		P/N:	BEER-28L-1112CPH
AE			0.814	cm ²	Core Effective Cross Sectional Area
LE			7.55	cm	Core Effective Path Length
AL			2520	nH/T ²	Ungapped Core Effective Inductance
BW			21.8	mm	Bobbin Physical Winding Width
M	3.2			mm	Safety Margin Width (Half the Primary to Secondary Creepage Distance)
L	2				Number of Primary Layers
NS	2				Number of Secondary Turns
DC INPUT VOLTAGE PARAMETERS					



VMIN			80	Volts	Minimum DC Input Voltage
VMAX			187	Volts	Maximum DC Input Voltage
CURRENT WAVEFORM SHAPE PARAMETERS					
DMAX			0.59		Maximum Duty Cycle
I AVG			1.07	Amps	Average Primary Current
IP			2.27	Amps	Peak Primary Current
IR			0.91	Amps	Primary Ripple Current
IRMS			1.41	Amps	Primary RMS Current
TRANSFORMER PRIMARY DESIGN PARAMETERS					
LP			356	μHenries	Primary Inductance
NP			53		Primary Winding Number of Turns
NB			7		Bias Winding Number of Turns
ALG			128	nH/T ²	Gapped Core Effective Inductance
BM			1886	Gauss	Maximum Flux Density at PO, VMIN (BM<3000)
BP			2630	Gauss	Peak Flux Density (BP<4200)
BAC			377	Gauss	AC Flux Density for Core Loss Curves (0.5 X Peak to Peak)
ur			1860		Relative Permeability of Ungapped Core
LG			0.76	mm	Gap Length (Lg > 0.1 mm)
BWE			30.8	mm	Effective Bobbin Width
OD			0.59	mm	Maximum Primary Wire Diameter including insulation
INS			0.07	mm	Estimated Total Insulation Thickness (= 2 * film thickness)
DIA			0.52	mm	Bare conductor diameter
AWG			24	AWG	Primary Wire Gauge (Rounded to next smaller standard AWG value)
CM			406	Cmils	Bare conductor effective area in circular mils
CMA			289	Cmils/Amp	Primary Winding Current Capacity (200 < CMA < 500)
TRANSFORMER SECONDARY DESIGN PARAMETERS (SINGLE OUTPUT / SINGLE OUTPUT EQUIVALENT)					
Lumped parameters					
ISP			59.79	Amps	Peak Secondary Current
ISRMS			31.05	Amps	Secondary RMS Current
IO			18.18	Amps	Power Supply Output Current
IRIPPLE			25.17	Amps	Output Capacitor RMS Ripple Current
CMS			6211	Cmils	Secondary Bare Conductor minimum circular mils
AWGS			12	AWG	Secondary Wire Gauge (Rounded up to next larger standard AWG value)
DIAS			2.05	mm	Secondary Minimum Bare Conductor Diameter
ODS			7.70	mm	Secondary Maximum Outside Diameter for Triple Insulated Wire
INSS			2.82	mm	Maximum Secondary Insulation Wall Thickness
VOLTAGE STRESS PARAMETERS					
VDRAIN			417	Volts	Maximum Drain Voltage Estimate (Includes Effect of Leakage Inductance)
PIVS			10	Volts	Output Rectifier Maximum Peak Inverse Voltage
PIVB			36	Volts	Bias Rectifier Maximum Peak Inverse Voltage
TRANSFORMER SECONDARY DESIGN PARAMETERS (MULTIPLE OUTPUTS)					
1st output					
VO1	5.0			Volts	Output Voltage
IO1	3.200			Amps	Output DC Current
PO1			16.00	Watts	Output Power
VD1	0.7			Volts	Output Diode Forward Voltage Drop



NS1			3.00		Output Winding Number of Turns
ISRMS1			5.465	Amps	Output Winding RMS Current
IRIPPLE1			4.43	Amps	Output Capacitor RMS Ripple Current
PIVS1			16	Volts	Output Rectifier Maximum Peak Inverse Voltage
CMS1			1093	Cmils	Output Winding Bare Conductor minimum circular mils
AWGS1			19	AWG	Wire Gauge (Rounded up to next larger standard AWG value)
DIAS1			0.91	mm	Minimum Bare Conductor Diameter
ODS1			5.13	mm	Maximum Outside Diameter for Triple Insulated Wire
2nd output					
VO2	12.0			Volts	Output Voltage
IO2	0.600			Amps	Output DC Current
PO2			7.20	Watts	Output Power
VD2	1.4			Volts	Output Diode Forward Voltage Drop
NS2			7.05		Output Winding Number of Turns
ISRMS2			1.025	Amps	Output Winding RMS Current
IRIPPLE2			0.83	Amps	Output Capacitor RMS Ripple Current
PIVS2			37	Volts	Output Rectifier Maximum Peak Inverse Voltage
CMS2			205	Cmils	Output Winding Bare Conductor minimum circular mils
AWGS2			26	AWG	Wire Gauge (Rounded up to next larger standard AWG value)
DIAS2			0.41	mm	Minimum Bare Conductor Diameter
ODS2			2.18	mm	Maximum Outside Diameter for Triple Insulated Wire
3rd output					
VO3	18.0			Volts	Output Voltage
IO3	0.500			Amps	Output DC Current
PO3			9.00	Watts	Output Power
VD3	1.4			Volts	Output Diode Forward Voltage Drop
NS3			10.21		Output Winding Number of Turns
ISRMS3			0.854	Amps	Output Winding RMS Current
IRIPPLE3			0.69	Amps	Output Capacitor RMS Ripple Current
PIVS3			54	Volts	Output Rectifier Maximum Peak Inverse Voltage
CMS3			171	Cmils	Output Winding Bare Conductor minimum circular mils
AWGS3			27	AWG	Wire Gauge (Rounded up to next larger standard AWG value)
DIAS3			0.36	mm	Minimum Bare Conductor Diameter
ODS3			1.51	mm	Maximum Outside Diameter for Triple Insulated Wire



15.9.2 115 V_{AC}, 45 W Steady State Load

ACDC_TOPGX_Rev1.1_040401 1 Copyright Power Integrations Inc. 2000	INPUT	INFO	OUTPUT	UNIT	TOP_GX_040401.xls: TOPSwitch-GX Continuous/Discontinuous Flyback Transformer Design Spreadsheet
ENTER APPLICATION VARIABLES					Customer
VACMIN	85			Volts	Minimum AC Input Voltage
VACMAX	132			Volts	Maximum AC Input Voltage
fL	50			Hertz	AC Mains Frequency
VO	3.3			Volts	Output Voltage
PO	45			Watts	Output Power
n	0.7				Efficiency Estimate
Z	0.5				Loss Allocation Factor
VB	12			Volts	Bias Voltage
tC	3			mSeconds	Bridge Rectifier Conduction Time Estimate
CIN	150			μFarads	Input Filter Capacitor
ENTER TOPSwitch-GX VARIABLES					
TOP-GX	TOP247			Universal	115 Doubled/230 V
Chosen Device		TOP247	Power Out	105 W	200 W
KI	0.8				External ILIMIT reduction factor (KI=1.0 for default ILIMIT, KI <1.0 for lower ILIMIT)
ILIMITMIN			2.592	Amps	Use 1% resistor in setting external ILIMIT
ILIMITMAX			3.168	Amps	Use 1% resistor in setting external ILIMIT
Frequency - (F)=130 kHz, (H)=65 kHz	f				Full (F) frequency option - 130 kHz
fS	130000		1.30E+05	Hertz	TOPSwitch-GX Switching Frequency: Choose between 130 kHz and 65 kHz
fSmin			1.24E+05	Hertz	TOPSwitch-GX Minimum Switching Frequency
fSmax			1.40E+05	Hertz	TOPSwitch-GX Maximum Switching Frequency
VOR	100			Volts	Reflected Output Voltage
VDS	10			Volts	TOPSwitch on-state Drain to Source Voltage
VD	0.5			Volts	Output Winding Diode Forward Voltage Drop
VDB	0.7			Volts	Bias Winding Diode Forward Voltage Drop
KP	0.55				Ripple to Peak Current Ratio (0.4 < KRP < 1.0 : 1.0 < KDP < 6.0)
ENTER TRANSFORMER CORE/CONSTRUCTION VARIABLES					
Core Type	EER28L				
Core		EER28L		P/N:	PC40EER28L-Z
Bobbin		EER28L_BOBBIN		P/N:	BEER-28L-1112CPH
AE			0.814	cm^2	Core Effective Cross Sectional Area
LE			7.55	cm	Core Effective Path Length
AL			2520	nH/T^2	Ungapped Core Effective Inductance
BW			21.8	mm	Bobbin Physical Winding Width
M	3.2			mm	Safety Margin Width (Half the Primary to Secondary Creepage Distance)
L	2				Number of Primary Layers
NS	2				Number of Secondary Turns
DC INPUT VOLTAGE PARAMETERS					
VMIN			92	Volts	Minimum DC Input Voltage
VMAX			187	Volts	Maximum DC Input Voltage
CURRENT WAVEFORM SHAPE PARAMETERS					



DMAX			0.55		Maximum Duty Cycle
Iavg			0.70	Amps	Average Primary Current
IP			1.75	Amps	Peak Primary Current
IR			0.97	Amps	Primary Ripple Current
IRMS			0.97	Amps	Primary RMS Current
TRANSFORMER PRIMARY DESIGN PARAMETERS					
LP			359	μHenries	Primary Inductance
NP			53		Primary Winding Number of Turns
NB			7		Bias Winding Number of Turns
ALG			130	nH/T ²	Gapped Core Effective Inductance
BM			1470	Gauss	Maximum Flux Density at PO, VMIN (BM<3000)
BP			2654	Gauss	Peak Flux Density (BP<4200)
BAC			404	Gauss	AC Flux Density for Core Loss Curves (0.5 X Peak to Peak)
ur			1860		Relative Permeability of Ungapped Core
LG			0.75	mm	Gap Length (Lg > 0.1 mm)
BWE			30.8	mm	Effective Bobbin Width
OD			0.59	mm	Maximum Primary Wire Diameter including insulation
INS			0.07	mm	Estimated Total Insulation Thickness (= 2 * film thickness)
DIA			0.52	mm	Bare conductor diameter
AWG			24	AWG	Primary Wire Gauge (Rounded to next smaller standard AWG value)
CM			406	Cmils	Bare conductor effective area in circular mils
CMA			421	Cmils/Amp	Primary Winding Current Capacity (200 < CMA < 500)
TRANSFORMER SECONDARY DESIGN PARAMETERS (SINGLE OUTPUT / SINGLE OUTPUT EQUIVALENT)					
Lumped parameters					
ISP			46.18	Amps	Peak Secondary Current
ISRMS			23.00	Amps	Secondary RMS Current
IO			13.64	Amps	Power Supply Output Current
IRIPPLE			18.52	Amps	Output Capacitor RMS Ripple Current
CMS			4600	Cmils	Secondary Bare Conductor minimum circular mils
AWGS			13	AWG	Secondary Wire Gauge (Rounded up to next larger standard AWG value)
DIAS			1.83	mm	Secondary Minimum Bare Conductor Diameter
ODS			7.70	mm	Secondary Maximum Outside Diameter for Triple Insulated Wire
INSS			2.94	mm	Maximum Secondary Insulation Wall Thickness
VOLTAGE STRESS PARAMETERS					
VDRAIN			417	Volts	Maximum Drain Voltage Estimate (Includes Effect of Leakage Inductance)
PIVS			10	Volts	Output Rectifier Maximum Peak Inverse Voltage
PIVB			36	Volts	Bias Rectifier Maximum Peak Inverse Voltage
TRANSFORMER SECONDARY DESIGN PARAMETERS (MULTIPLE OUTPUTS)					
1st output					
VO1	5.0			Volts	Output Voltage
IO1	3.200			Amps	Output DC Current
PO1			16.00	Watts	Output Power
VD1	0.7			Volts	Output Diode Forward Voltage Drop
NS1			3.00		Output Winding Number of Turns
ISRMS1			5.397	Amps	Output Winding RMS Current



IRIPPLE1			4.35	Amps	Output Capacitor RMS Ripple Current
PIVS1			16	Volts	Output Rectifier Maximum Peak Inverse Voltage
CMS1			1079	Cmils	Output Winding Bare Conductor minimum circular mils
AWGS1			19	AWG	Wire Gauge (Rounded up to next larger standard AWG value)
DIAS1			0.91	mm	Minimum Bare Conductor Diameter
ODS1			5.13	mm	Maximum Outside Diameter for Triple Insulated Wire
2nd output					
VO2	12.0			Volts	Output Voltage
IO2	0.600			Amps	Output DC Current
PO2			7.20	Watts	Output Power
VD2	1.4			Volts	Output Diode Forward Voltage Drop
NS2			7.05		Output Winding Number of Turns
ISRMS2			1.012	Amps	Output Winding RMS Current
IRIPPLE2			0.81	Amps	Output Capacitor RMS Ripple Current
PIVS2			37	Volts	Output Rectifier Maximum Peak Inverse Voltage
CMS2			202	Cmils	Output Winding Bare Conductor minimum circular mils
AWGS2			27	AWG	Wire Gauge (Rounded up to next larger standard AWG value)
DIAS2			0.36	mm	Minimum Bare Conductor Diameter
ODS2			2.18	mm	Maximum Outside Diameter for Triple Insulated Wire
3rd output					
VO3	30.0			Volts	Output Voltage
IO3	0.030			Amps	Output DC Current
PO3			0.90	Watts	Output Power
VD3	1.4			Volts	Output Diode Forward Voltage Drop
NS3			16.53		Output Winding Number of Turns
ISRMS3			0.051	Amps	Output Winding RMS Current
IRIPPLE3			0.04	Amps	Output Capacitor RMS Ripple Current
PIVS3			89	Volts	Output Rectifier Maximum Peak Inverse Voltage
CMS3			10	Cmils	Output Winding Bare Conductor minimum circular mils
AWGS3			39	AWG	Wire Gauge (Rounded up to next larger standard AWG value)
DIAS3			0.09	mm	Minimum Bare Conductor Diameter
ODS3			0.93	mm	Maximum Outside Diameter for Triple Insulated Wire



15.10 List of Included Parts for 230 VAC-115 VAC Conversion

Set-Top GX, 115 V, Conversion Kit

Bill Of Materials

Item	Qty	Reference	Description	P/N	Manufacturer
1	1	C2	150 μ F, 200 VEB	EEU-EB2D151	Panasonic
2	4	C13,14,16,17	1200 μ F, 35 V FA	EEU-FA1V122L	Panasonic
3	2	C21,22	0.1 μ F, 50 V	K104M15Z5UF5TH5	Beyersschlag/Centralab
4	4	D1-4	2 A, 600 v	RL205	Diodes, Inc.
5	1	L1	18 mH, 1.3 A	ELF-20N013A	Panasonic
6	1	R12	18 k Ω , 1/4 W, 5%		
7	1	T1	Transformer, Custom,	ERL28	
8	1	U1	TOP247Y		
9	1	RT1	Thermistor, 10 Ω , 3.2 A	KC011L	Keystone
10	1	JP5	Zero ohm resistor		

15.11 EP13 230 VAC-115 VAC Conversion Instructions

15.11.1 Required Tools and Supplies

- 1) Soldering iron
- 2) Solder
- 3) Pliers
- 4) Desoldering tool/solder wick
- 5) Philips screwdriver
- 6) Thermal compound

15.11.2 Conversion Instructions

- 1) Remove C2, C13-17, D1-4, L1, T1, U1, and RT1. Retain mounting screw and nut from U1 heat sink for reuse.
- 2) Replace C2 with 150 μ F, 200 V capacitor from conversion kit. Observe proper polarity.
- 3) Replace C13, 14, 16, and 17 with 1200 μ F, 35 V capacitors from conversion kit. Observe proper polarity.
- 4) Replace D1-4 with RL205 diodes from conversion kit. Check for proper diode polarity according to PCB silkscreen.
- 5) Replace L1 with 18 mH common mode inductor from conversion kit.
- 6) Replace U1 with TOP247Y from conversion kit. Use thermal compound between device mounting tab and heat sink to assure proper thermal interface.
- 7) Replace T1 with transformer from conversion kit.
- 8) Replace RT1 with thermistor from conversion kit.
- 9) Populate C21 and C22 positions with 0.1 μ F capacitors from conversion kit.
- 10) Populate R12 position with 18 k Ω resistor from conversion kit.
- 11) Populate JP5 position using zero ohm resistor from conversion kit.



16 Appendix B Miscellaneous Custom Parts

16.1 Secondary Heat Sink

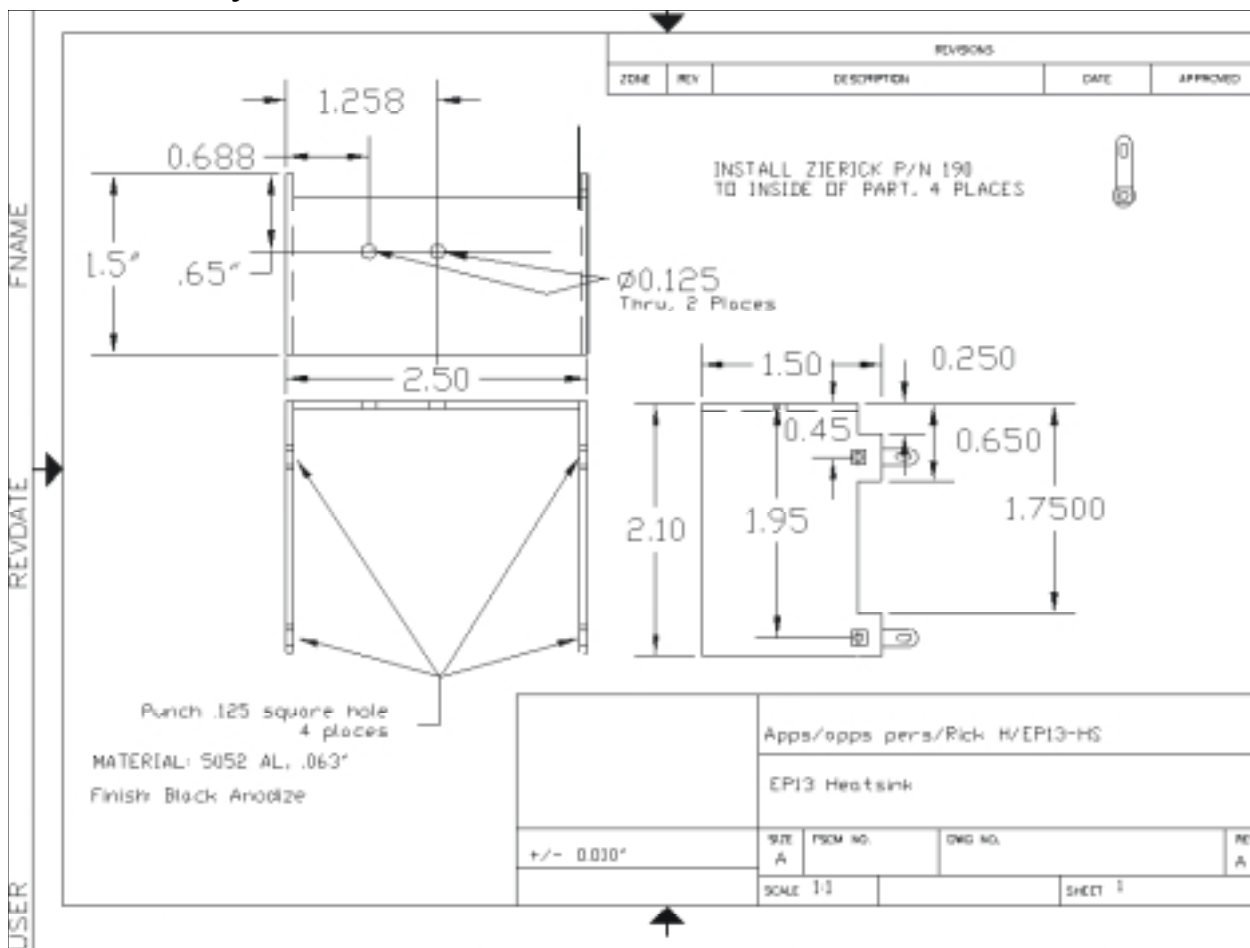

Figure 41 - EP13 Secondary Heat Sink Drawing.



17 Revision History

Date	Author	Revision	Description & changes
25-Jan-2001	RH	0.1	First draft
12-Apr-2001	RH	0.2	Second draft
16-Apr-2001	RH	0.3	Third Draft
08-May-2001	RH	1.0	First Release



Notes



Notes



For the latest updates, visit our website: www.powerint.com

Power Integrations reserves the right to make changes to its products at any time to improve reliability or manufacturability. Power Integrations does not assume any liability arising from the use of any device or circuit described herein, nor does it convey any license under its patent rights or the rights of others.

PI Logo, *TOPSwitch* and *TinySwitch* are registered trademarks of Power Integrations, Inc.

©Copyright 2001, Power Integrations, Inc.

WORLD HEADQUARTERS

NORTH AMERICA - WEST

Power Integrations, Inc.
5245 Hellyer Avenue
San Jose, CA 95138 USA.
Main: +1•408•414•9200
Customer Service:
Phone: +1•408•414•9665
Fax: +1•408•414•9765

NORTH AMERICA - EAST & SOUTH AMERICA

Power Integrations, Inc.
Eastern Area Sales Office
1343 Canton Road, Suite C1
Marietta, GA 30066 USA
Phone: +1•770•424•5152
Fax: +1•770•424•6567

EUROPE & AFRICA

Power Integrations (Europe) Ltd.
Centennial Court
Easthampstead Road
Bracknell
Berkshire RG12 1YQ,
United Kingdom
Phone: +44•1344•462•301
Fax: +44•1344•311•732

TAIWAN

Power Integrations International
Holdings, Inc.
2F, #508, Chung Hsiao E. Rd.,
Sec. 5,
Taipei 105, Taiwan
Phone: +886•2•2727•1221
Fax: +886•2•2727•1223

CHINA

Power Integrations
International
Holdings, Inc.
Rm# 1705, Bao Hua Bldg.
1016 Hua Qiang Bei Lu
Shenzhen Guangdong,
518031
Phone: +86•755•367•5143
Fax: +86•755•377•9610

KOREA

Power Integrations
International
Holdings, Inc.
Rm# 402, Handuk Building,
649-4 Yeoksam-Dong,
Kangnam-Gu,
Seoul, Korea
Phone: +82•2•568•7520
Fax: +82•2•568•7474

JAPAN

Power Integrations, K.K.
Keihin-Tatemono 1st Bldg.
12-20 Shin-Yokohama 2-
Chome,
Kohoku-ku, Yokohama-shi,
Kanagawa 222, Japan
Phone: +81•45•471•1021
Fax: +81•45•471•3717

INDIA (Technical Support)

Innovatech
#1, 8th Main Road
Vasanthnagar
Bangalore, India 560052
Phone: +91•80•226•6023
Fax: +91•80•228•9727

APPLICATIONS HOTLINE

World Wide +1•408•414•9660

APPLICATIONS FAX

World Wide +1•408•414•9760

